

# KOBELCO

SK30SR-7/SK35SR-7

Performance  Design

## SK30SR SK35SR

■ Bucket capacity:

SK30SR 0.09 m<sup>3</sup>

SK35SR 0.11 m<sup>3</sup>

■ Engine power:

18.9 kW / 2,400 min<sup>-1</sup>

■ Operating weight:

SK30SR 3,410–3,690 kg

SK35SR 3,810–4,080 kg



*We Save You Fuel*  
Achieving a Low-Carbon Society

# Performance Design

With the release of the SK30SR and SK35SR, KOBELCO has completely harmonised the values of PERFORMANCE and DESIGN.

These mini excavators deliver great efficiency and productivity with increased power, along with uncompromising operator comfort and machine operability.

In the pursuit of producing unique and unbeatable machines that provide comfort and productivity without equal, KOBELCO continues to rise to the challenge.





# UNFORGETTABLE COMFORT

True ergonomic functionality combined with modern design has resulted in a interior design that is sleek and comfortable.





### Suspension seat

A proven Grammer\* suspension seat is fitted as standard equipment, offering a reclining mechanism, excellent shock absorption and superior ride comfort. \*GRAMMER is trademark of GRAMMER AG. registered in Germany and other countries.

### Wrist rests

The large wrist rests keep the operator's forearms in a stable position, reducing fatigue during operation, and allowing stable operation.



### Air conditioner

Additional air vents are placed around the cabin for optimal air flow around operator. In addition, the defrosters placed in the front, right and back have also been improved to ensure visibility when the air conditioner is in use.



### LED backlights

LED backlighting on switches and dials provides a bright, clear view of controls, even in the dark, while delivering a premium look and feel.



### Smartphone holder/ USB/AUX port

# FUNCTIONAL WORK ENVIRONMENT

Realisation of the operator's convenience and comfort.



## Colour monitor

The colour display is easy to read and comes as standard and shows various information such as operating history, maintenance cycle, and fuel and water temperature gauges. It can also be used to adjust the hydraulic oil flow to the attachments.



## Energy conservation mode

There are 2 working modes: one for maximum power, and ECO-mode for increased fuel economy.



## Auto deceleration

Auto deceleration saves fuel and lowers engine noise by lowering engine speed to idle.



## Hydraulic flow adjustment

Rotation or NGB piping flow can be selected from six preset types, or adjusted arbitrarily.



## Engine start password

A password is required when starting the engine for greater security.



## Maintenance information



## Operation history



### Easy-access cab

The hinged door is used to provide easy cabin access. Furthermore, the flip-up left console with integrated pilot control lock lever allows for easy entry and exit from the cab.



### Ergonomic lever angles

Operators can move levers horizontally without twisting their wrists, reducing operator fatigue.

### Proportional hand control for rotation & N&B piping (Option)

Precise proportional controls are integrated into the joystick for ease of operation.



### Slide-open window

The right side window can slide open from the front or the back for increased ventilation and to hear ground workers when required.



### Speaker



### Coat hook



### Cup holder



### Utility box



### LED door light



### 12V power outlet



### Front under glass holder



### Boom swing control with HCP



### FM/AM radio & AUX & Bluetooth® & hands-free telephone



# THE NEXT LEVEL OF PERFORMANCE

By replacing the bucket cylinder, the bucket digging force is increased.

»» Bucket digging force

Raised by **16%**

(Compared to previous models)

The engine output is increased compared to previous models, providing extra power.

»» Engine output

**18.9 kW / 2,400 min<sup>-1</sup>**

The newly adopted ECO-mode saves even more energy.

»» Fuel consumption

Reduced by **25%**

(Compared to H-mode)



### Smoother operation

The new hydraulic system improves levelling performance.

### Integrated-Flow Pump System

During the digging operation, depending upon job condition, the machine provides the additional flow to the boom, arm or bucket circuit, from No.3 pump (swing and dozer pump), to increase available input power to those functions.

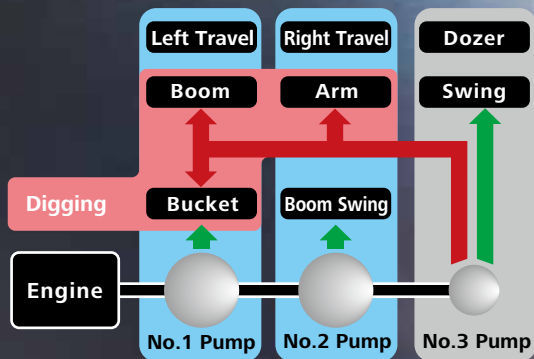

# COMPACT SIZE, BIG PERFORMANCE

Min. swing radius  
at boom swing

1,910 mm (SK305R)  
1,930 mm (SK355R)

Figures above show the values for  
cab with standard arm spec.

Tail swing  
radius

775 mm (SK305R)  
850 mm (SK355R)

## Short tail swing

The compact tail swing improves  
operating efficiency in limited space.

## Tail overhang

**0 mm (90 mm)**

(without rear view mirror)

Figure in ( ) shows the value with  
additional counterweight.



5,200 mm (SK305R)  
5,350 mm (SK355R)

5,050 mm (SK305R Canopy)  
5,040 mm (SK355R Canopy)  
4,790 mm (SK305R Cab)  
4,870 mm (SK355R Cab)

2,830 mm (SK305R)  
3,050 mm (SK355R)

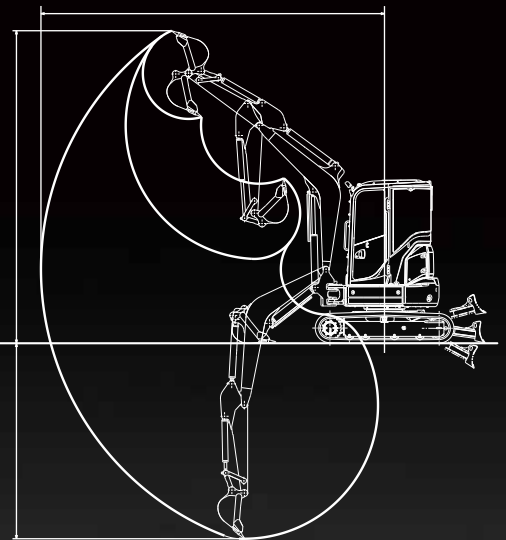

Arm length 1.32 m (SK305R)  
1.37 m (SK355R)

Figures above show the values for cab.

## Wide working range

Long arms are provided as optional  
equipment to ensure a wide working range.

# VERSATILE



## Hydraulic piping for quick hitch

For increased efficiency, various attachments, such as the bucket, can be easily mounted and dismantled without leaving the cab.



## Dozer lever

The new ergonomic dozer lever has a 1st/2nd travel speed select switch integrated into the handle for easier dozer functions.

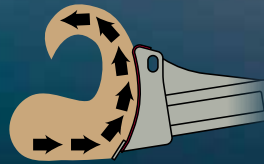

## Dozer-blade shape

KOBELCO's unique blade design pushes the earth into an arc that always falls forward. Because this prevents material from falling behind the blade, only one pass is needed.



## Angle dozer (Option)

Built with the same durability as the standard blade, this angle option provides 25 to 25 degrees of left and right angle movement for clearing, grading and back-filling.

The angle dozer gives you better control for following changing terrain.

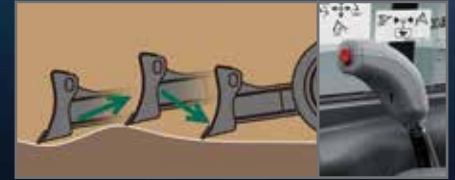

## Floating dozer (Option)

Dozer float is optional to assist in easier leveling work. Floating function can be activated by the switch which is integrated into the dozer control lever.

# LEGENDARY RELIABILITY

The boom, arm and swing bracket all have large cross-section segments for added attachment strength.

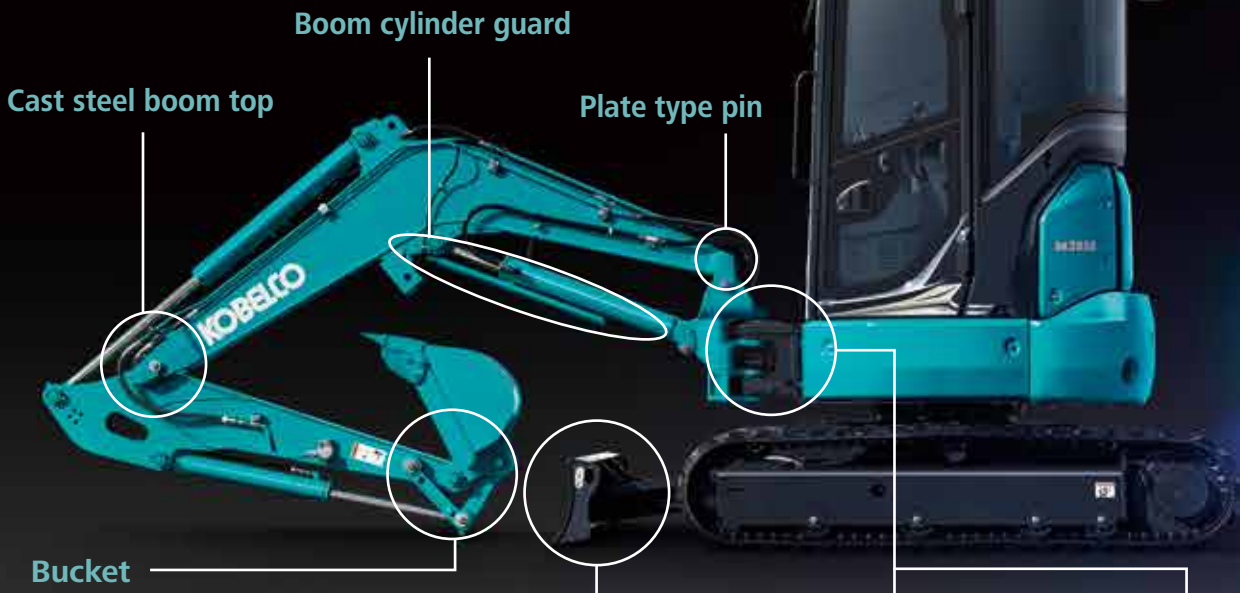

Boom cylinder guard

Cast steel boom top

Plate type pin

Bucket

Cast-iron idler link provides greater strength.



Dozer

Reinforced dozer supports provide greater strength.



Swing bracket

Large, thick cast-iron swing bracket/front bracket.



Hydraulic hosing

The hydraulic hosing is housed inside the swing bracket for protection.

# NON-STOP OPERATION BY iNDr

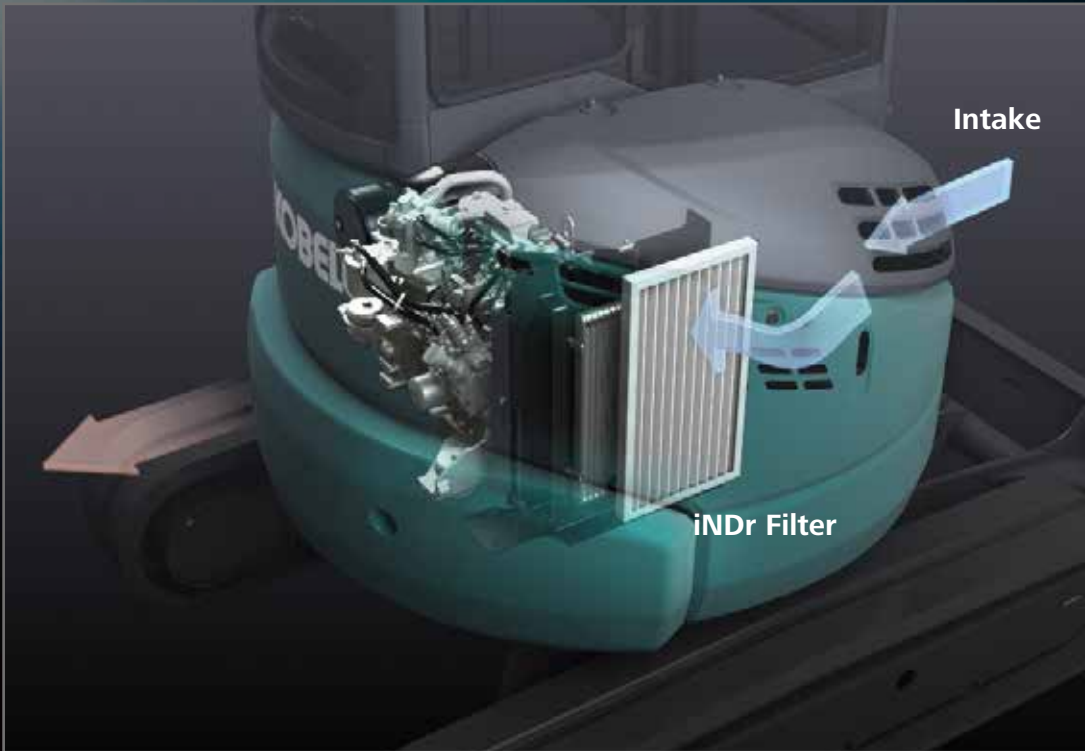

## iNDr

A high-density mesh filter blocks dust and debris from entering the cooling package during air intake. This prevents the cooling device and the air cleaner from clogging, allowing the machine to maintain cooling performance.

The ridges of the corrugated filter allow air to pass through, while the grooves collect dust and debris, preventing the filter from clogging.

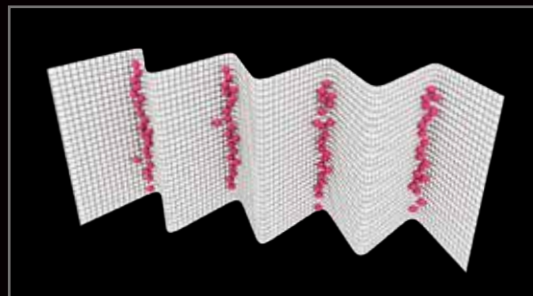

The iNDr filter has a high-density mesh of 30 lines per inch to collect dust.

# EASY MAINTENANCE

Easy daily maintenance to reduce machine downtime.



## Easy Access to Component Inside the Cab



Hour meter



Cab fresh air intake filter



Cab re-circulation air filter



Operator manual storage pockets

## Easy Access to Cooling Unit



iNDR filter

Laid out for easy access to radiator and cooling system.

## Easy Access to Engine Compartment



- ① Pre fuel filter with built-in water separator
- ② Air cleaner
- ③ High-grade fuel filter

# OPERATOR SAFETY



## Reliable cab/canopy structure

The high-strength cab/canopy meets ROPS, TOPS and OPG Level 1 (Top guard) standards for greater operator safety.



## LED work light

Changed from halogen light to LED light for more brightness.



## Safety valve for boom cylinder (Option)



## Safety valve for arm cylinder (Option)



## Improved visibility

The wiper mount has been moved to the upper right of the cab support and the skylight opening has been enlarged, improving visibility to the front and above.



## Rear view mirror



## Rear under mirror



## Hammer for emergency exit



## Accumulator for emergency attachment lowering

An installed accumulator allows the attachment to be safely lowered to the ground using in-cab controls in the event of an unexpected engine shut-down with class leading smooth operation.

## Standard and Optional Equipment

●=Std ○=Opt — = N/A

Category	Description	SK30SR-7	SK35SR-7
<b>ENGINE</b>	YANMAR 3TNV88 (Stage V compliant)	●	●
	Alternator 12 V /40 A	●	●
	Starter motor 12 V/1.7 kW	●	●
	Battery 1x 12 V (80 Ah)	●	●
	Fan suction type cooling system	●	●
	iNDR system	●	●
	Auto deceleration function	●	●
	Accelerator dial	●	●
	ECO-mode	●	●
Engine start password	●	●	
<b>HYDRAULIC SYSTEM</b>	Integrated-Flow Pump System	●	●
	PHC (for N&B piping) with hydraulic flow adjustment	●	●
	PHC (for Rotation &N&B piping) with hydraulic flow adjustment	○	○
	Hydraulic oil VG32	○	○
	Hydraulic oil VG46	○	○
<b>PIPING</b>	N&B piping	●	●
	Rotation &N&B piping	○	○
	QH piping	●	●
<b>CABIN</b>	Suspension seat (Canopy: PVC / Cab: fabric)	●	●
	Headrest*	●	●
	Retractable seatbelt	●	●
	Multi-function color display	●	●
	LED door light*	●	●
	Air-conditioner*	●	●
	FM/AM radio (AUX & Bluetooth®)*	●	●
	Cup holder	●	●
	Coat hook*	●	●
	Smart phone holder*	●	●
	USB/AUX port*	●	●
	12V power outlet	●	●
Harness for cab beacon light*	●	●	
<b>LIGHTS</b>	LED work lights ; 1 on boom, 2 on cab top front / 1 on canopy front	●	●
<b>WORKING EQUIPMENT</b>	Standard boom (2.36 m)	●	—
	Standard boom (2.47 m)	—	●
	Standard arm (1.32 m)	●	—
	Standard arm (1.37 m)	—	●
	Long arm (1.62 m)	○	—
	Long arm (1.67 m)	—	○
	0.05 m <sup>3</sup> (350mm) bucket	○	○
	0.07 m <sup>3</sup> (450 mm) bucket	○	○
	0.08 m <sup>3</sup> (500 mm) bucket	○	○
	0.10 m <sup>3</sup> (600 mm) bucket	○	○
0.12 m <sup>3</sup> (700 mm) bucket	○	○	
<b>COUNTER WEIGHT</b>	Standard C/W	●	●
	Additional C/W (+250 kg)	○	○
<b>UNDERCARRIAGE</b>	300mm rubber shoe	●	●
	300mm steel shoe	○	○
	Dozer blade (1,550 mm)	●	—
	Dozer blade (1,700 mm)	—	●
	Floating dozer	○	○
	Angle dozer	○	○
<b>SAFETY EQUIPMENT</b>	Cab (ROPS(ISO 3471 : 2008) / TOPS(ISO 12117 : 1997) / OPG(ISO 10262 : 1998)	●	●
	Canopy (ROPS(ISO 3471 : 2008) / TOPS(ISO 12117 : 1997) / OPG(ISO 10262 : 1998)	○	○
	Front guard	○	○
	Top guard*	○	○
	Rear view mirror (left)	●	●
	Rear under mirror (right rear)	●	●
	Travel alarm	●	●
<b>OTHERS</b>	Boom cylinder rod guard	●	●
	Arm & bucket cylinder rod guard	○	○
	RAL colour	○	○

\* Only for Cab

Note: Bluetooth® is a registered trademark of the Bluetooth SIG Inc.

# Specifications

## Engine

Model	<b>YANMAR 3TNV88</b>
Type	Four-cycle, water-cooled, direct injection diesel engine, complies with EU Stage V exhaust emission regulation
No. of cylinders	3
Bore and stroke	88 mm × 90 mm
Displacement	1,642 ml
Rated power output	17.9 kW / 2,400min <sup>-1</sup> (ISO 9249 : with fan)
	18.9 kW / 2,400 min <sup>-1</sup> (ISO 14396: without fan)
Max. torque	88.0 N·m / 1,440 min <sup>-1</sup> (ISO 14396: without fan)

## Hydraulic system

Pump	
Type	Two variable displacement axial piston pumps + one gear pump + pilot pump
Max. discharge flow	2 × 38.4 L/min, 1 × 19.2 L/min, 1 × 10.8L/min
Relief valve setting	
Boom, arm and bucket	23.0 MPa {235 kgf/cm <sup>2</sup> }
Travel circuit	23.0 MPa {235 kgf/cm <sup>2</sup> }
Swing circuit	20.0 MPa {204 kgf/cm <sup>2</sup> }
Blade circuit	23.0 MPa {235 kgf/cm <sup>2</sup> }
Control circuit	3.5 MPa {36 kgf/cm <sup>2</sup> }
Pilot control pump	Gear type
Main control valve	10-Spool valve
Oil cooler	Air cooled type

## Swing system

Swing motor	One fixed displacement piston motor
Brake	Hydraulic; locking automatically when the swing control lever is in the neutral position
Parking brake	Wet multiple plate
Swing speed	8.2 min <sup>-1</sup>
Swing torque	7.0 kN·m

## Dozer blade

Dozer cylinder	90 mm × 180 mm
----------------	----------------

## Travel system

Travel motors	Two Variable displacement piston motor
Travel brakes	Hydraulic brake
Parking brakes	Wet multiple plate
Travel shoes	88 each side
Travel speed	4.4/2.5 km/h (rubber shoe)
	4.3/2.4 km/h (steel shoe)
Drawbar pulling force	SK30SR 38.1 kN (Cab) / 38.2 kN (Canopy)
	SK35SR 37.9 kN (Cab) / 38.0 kN (Canopy)
Gradeability	58 % {30 °}

## Cab & control

Cab	All-weather, insulated floor mat.
Control	Two hand levers and two foot pedals for travel
	Two hand levers for excavating and swing
	Electric rotary-type engine throttle
	Foot control (for boom swing)
	Foot control (for N&B piping)
	Dozer lever

## Boom, arm & bucket

Model	SK30SR		SK35SR	
	Cab	Canopy	Cab	Canopy
Boom cylinders	80 mm × 574 mm	80 mm × 592 mm	85 mm × 582 mm	85 mm × 588 mm
Arm cylinder	75 mm × 627 mm		80 mm × 677 mm	
Bucket cylinder	70 mm × 507 mm			
Swing cylinder	80 mm × 477 mm			

## Refilling capacities & lubrications

Fuel tank	42 L
Cooling system	3.8 L
Engine oil	6.7 L
Travel reduction gear	2 × 0.6 L
Hydraulic oil tank	20.4 L tank oil level
	44.8 L hydraulic system

## Operating weight & ground pressure

In standard trim, with standard boom, standard arm, and 0.09 m<sup>3</sup> (80 kg) – 0.11 m<sup>3</sup> (80 kg) bucket

Model	SK30SR				SK35SR			
	Cab		Canopy		Cab		Canopy	
Shaped	Steel shoe	Rubber shoe	Steel shoe	Rubber shoe	Steel shoe	Rubber shoe	Steel shoe	Rubber shoe
Shoe width	300							
Overall width of crawler	1,550				1,700			
Ground pressure	32.4	31.4	31	30	35.8	34.8	34.4	33.4
Operating weight	3,690	3,570	3,540	3,410	4,080	3,960	3,920	3,810
Machine Mass	3,620	3,500	3,460	3,340	4,000	3,890	3,850	3,730

\* Regarding bucket capacity, 0.09 m<sup>3</sup> in this catalogue is equivalent to 0.08 m<sup>3</sup> in ISO 07451 and 0.11 m<sup>3</sup> in this catalogue is equivalent to 0.10 m<sup>3</sup> in ISO 07451



## Working ranges

Unit: mm

Model	SK30SR		SK35SR	
	Cab	Canopy	Cab	Canopy
Arm length	1.32 m		1.37 m	
a- Max. digging reach	5,200		5,350	
b- Max. digging reach at ground level	5,040		5,200	
c- Max. digging depth	2,830	2,780	3,050	2,970
d- Max. digging height	4,790	5,050	4,870	5,040
e- Max. dumping clearance	3,410	3,640	3,490	3,650
f- Min. dumping clearance	1,290	1,430	1,310	1,400
g- Max. vertical wall digging depth	2,370		2,470	
h- Min. swing radius at boom straight	2,300	2,190	2,320	2,180
h'- Min. swing radius at boom swing	1,910	1,810	1,930	1,810
i- Horizontal digging stroke at ground level	2,230		2,400	
j- Digging depth for 2.4 m (8') flat bottom	2,360	2,310	2,580	2,510
k- Dozer blade (height/depth) (mm)	470/390			

\*Figures in the above tables show the value with 0.09–0.11 m<sup>3</sup> bucket.  
Regarding bucket capacity, 0.09 m<sup>3</sup> in this catalogue is equivalent to 0.08 m<sup>3</sup> in ISO07451 and 0.11 m<sup>3</sup> in this catalogue is equivalent to 0.10 m<sup>3</sup> in ISO07451.

## Digging force (ISO 6015)

Unit: kN

Model	SK30SR	SK35SR
Arm length	1.32 m / 1.37 m	
Bucket digging force	32.2	
Arm crowding force	19.1	22.4

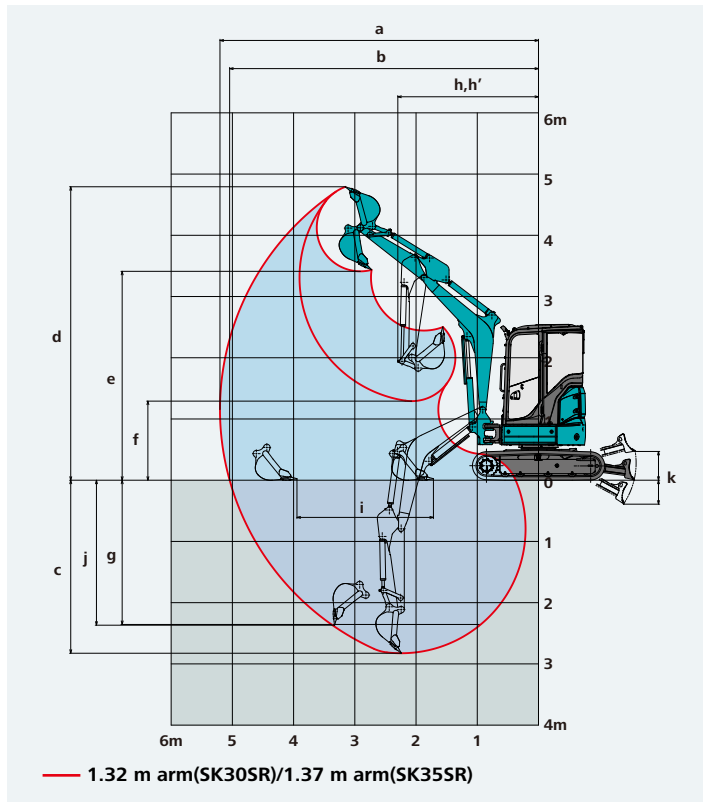

## Dimensions

Model	SK30SR		SK35SR	
	Cab	Canopy	Cab	Canopy
Arm length	1.32 m		1.37 m	
A Overall length	4,730		4,820	
B Overall width	1,550		1,700	
C Overall height (to top of cab/canopy)	2,550		2,550	
D Ground clearance of rear end*	575		570	
E Tail swing radius	775		850	
F Distance from center of swing to rear end	775		850	
G Tumbler distance	1,700		1,700	
H Overall length of crawler	2,160		2,160	
I Track gauge	1,250		1,400	
J Shoe width	300		300	
K Overall width of upper structure	1,530		1,530	

Unit: mm

L Blade width	1,550	1,700
M Blade height	345	345
N Distance from dozer top to center of upper structure	1,560	1,560
O Basic machine length	2,650	2,650
P Digging distance outside crawler shoe (right)	250	225
Q Boom offset volume (right)	725	725
R Boom offset volume (left)	720	720
S Digging distance outside crawler shoe (left)	145	120
T Offset volume of boom center	50	50
U Boom swing angle (Left/Right)	70°/60°	70°/60°

\*Without including height of shoe lug

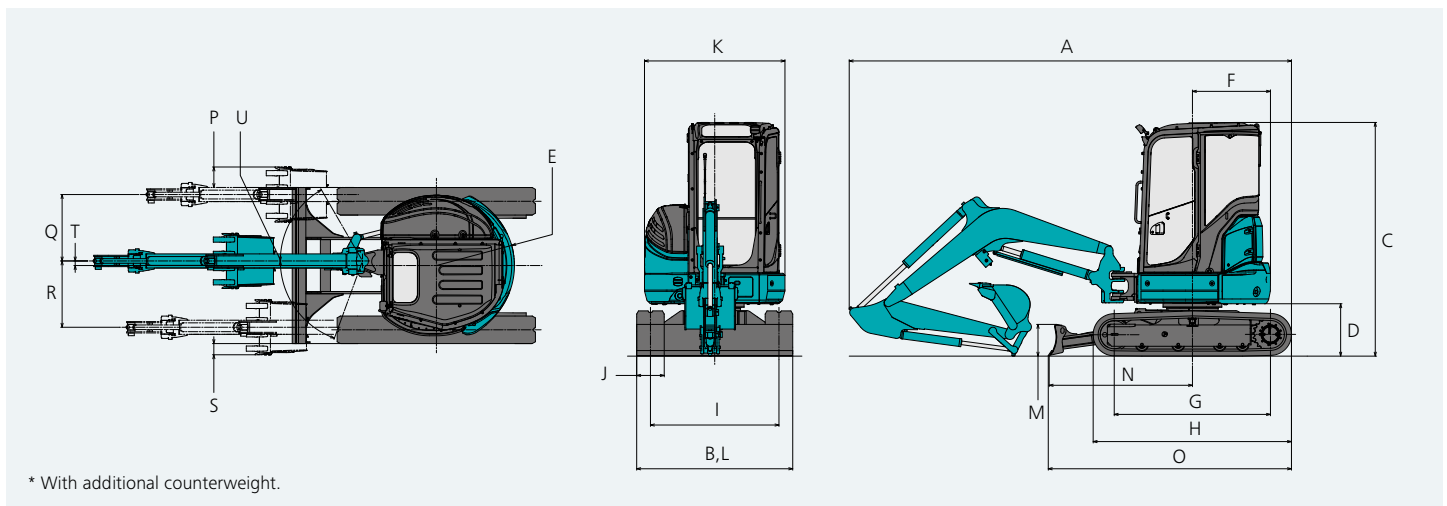

\* With additional counterweight.

# Lift capacities

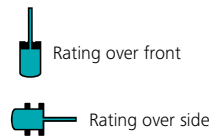
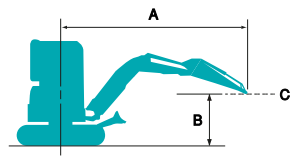











A: Reach from swing centreline to arm top  
 B: Arm top height above/below ground  
 C: Lift point  
 Bucket: Without  
 Dozer: Blade up  
 Relief valve setting: 23.0 MPa











SK30SR Canopy		Arm: 1.32 m Standard counterweight Rubber shoe: 300 mm										
B	A	1.0m		2.0m		3.0m		4.0m		At max. reach		Radius
4.0m	kg					770	600			730	570	3.08m
3.0m	kg					*750	610			470	370	3.98m
2.0m	kg					730	570	460	360	390	300	4.39m
1.0m	kg					670	510	430	340	360	280	4.49m
G.L.	kg			1,230	890	640	480	420	320	380	290	4.30m
-1.0m	kg	*2,050	*2,050	1,250	900	640	480			460	360	3.77m
-2.0m	kg			*970	960					*640	*640	2.60m











SK30SR Cab		Arm: 1.32 m Standard counterweight Rubber shoe: 300 mm										
B	A	1.0m		2.0m		3.0m		4.0m		At max. reach		Radius
4.0m	kg					810	640			770	610	3.08m
3.0m	kg									500	390	3.98m
2.0m	kg					770	600	490	380	420	320	4.39m
1.0m	kg					720	550	470	360	390	300	4.49m
G.L.	kg			1,320	950	680	520	450	350	410	320	4.30m
-1.0m	kg	*2,050	*2,050	1,340	970	690	520			500	380	3.77m
-2.0m	kg			*970	*970					*640	*640	2.60m











SK30SR Canopy		Arm: 1.32 m Additional counterweight (+250 kg) Rubber shoe: 300 mm										
B	A	1.0m		2.0m		3.0m		4.0m		At max. reach		Radius
4.0m	kg					*820	730			*840	690	3.08m
3.0m	kg					*750	730			570	460	3.98m
2.0m	kg					880	690	560	440	480	380	4.39m
1.0m	kg					820	640	540	420	450	360	4.49m
G.L.	kg			1,510	1,110	790	610	520	410	470	370	4.30m
-1.0m	kg	*2,050	*2,050	1,530	1,120	790	610			570	450	3.77m
-2.0m	kg			*970	*970					*640	*640	2.61m

SK30SR Cab		Arm: 1.32 m Additional counterweight (+250 kg) Rubber shoe: 300 mm										
B	A	1.0m		2.0m		3.0m		4.0m		At max. reach		Radius
4.0m	kg					*820	760			*840	730	3.08m
3.0m	kg									640	480	3.98m
2.0m	kg					*970	730	630	470	540	400	4.39m
1.0m	kg					920	670	610	450	510	380	4.49m
G.L.	kg			*1,540	1,170	890	640	590	440	540	400	4.30m
-1.0m	kg	*2,050	*2,050	1,720	1,190	890	640			650	480	3.77m
-2.0m	kg			*970	*970					*640	*640	2.61m

SK35SR Canopy		Arm: 1.37 m Standard counterweight Rubber shoe: 300 mm										
B	A	1.0m		2.0m		3.0m		4.0m		At max. reach		Radius
												
4.0m	kg									790	740	3.32m
3.0m	kg							580	550	540	510	4.15m
2.0m	kg					890	830	570	530	460	430	4.54m
1.0m	kg					820	760	540	510	430	410	4.64m
G.L.	kg			1,520	1,360	790	730	520	490	450	420	4.46m
-1.0m	kg	*2,290	*2,290	1,540	1,380	790	730			540	500	3.96m
-2.0m	kg			*1,540	1,440					870	810	2.90m

SK35SR Cab		Arm: 1.37 m Standard counterweight Rubber shoe: 300 mm										
B	A	1.0m		2.0m		3.0m		4.0m		At max. reach		Radius
												
4.0m	kg									*830	770	3.32m
3.0m	kg							610	570	570	530	4.15m
2.0m	kg					930	860	590	560	480	450	4.54m
1.0m	kg					870	800	570	530	460	430	4.64m
G.L.	kg			1,600	1,430	830	770	550	510	480	450	4.46m
-1.0m	kg	*2,290	*2,290	1,620	1,450	830	770			570	530	3.96m
-2.0m	kg			*1,540	1,500					*890	840	2.90m

SK35SR Canopy		Arm: 1.37 m Additional counterweight (+250 kg) Rubber shoe: 300 mm										
B	A	1.0m		2.0m		3.0m		4.0m		At max. reach		Radius
												
4.0m	kg									*830	*830	3.32m
3.0m	kg							680	640	640	600	4.15m
2.0m	kg					*1,030	960	670	620	550	510	4.54m
1.0m	kg					970	900	640	600	520	490	4.64m
G.L.	kg			*1,650	1,610	940	870	630	580	540	510	4.46m
-1.0m	kg	*2,290	*2,290	1,820	1,630	940	870			640	600	3.96m
-2.0m	kg			*1,540	*1,540					*890	*890	2.90m

SK35SR Cab		Arm: 1.37 m Additional counterweight (+250 kg) Rubber shoe: 300 mm										
B	A	1.0m		2.0m		3.0m		4.0m		At max. reach		Radius
												
4.0m	kg									*830	*830	3.32m
3.0m	kg							710	660	670	620	4.15m
2.0m	kg					*1,030	1,000	700	650	570	530	4.54m
1.0m	kg					1,010	940	670	620	540	510	4.64m
G.L.	kg			*1,650	*1,650	980	900	650	610	570	530	4.46m
-1.0m	kg	*2,290	*2,290	1,890	1,690	980	900			670	620	3.96m
-2.0m	kg			*1,540	*1,540					*890	*890	2.90m

1. Do not attempt to lift or hold any load that is greater than these lift capacities at their specified lift point radius and heights. Weight of all accessories must be deducted from the above lift capacities.
2. Lift capacities are based on machine standing on level, firm, and uniform ground. User must make allowance for job conditions such as soft or uneven ground, out of level conditions, side loads, sudden stopping of loads, hazardous conditions, experience of personnel, etc.
3. Arm top defined as lift point.
4. The above lift capacities are in compliance with ISO 10567. They do not exceed 87% of hydraulic lift capacity or 75% of tipping load. Lift capacities marked with an asterisk(\*) are limited by hydraulic capacity rather than tipping load.
5. Operator should be fully acquainted with the Operator's and Maintenance Instructions before operating this machine. Rules for safe operation of equipment should be adhered to at all times.
6. Lift capacities apply to only machine as originally manufactured and normally equipped by KOBELCO CONSTRUCTION MACHINERY CO., LTD.

---

Note: This catalogue may contain attachments and optional equipment that are not available in your area. And it may contain photographs of machines with specifications that differ from those of machines sold in your areas. Please consult your nearest KOBELCO distributor for those items you require.  
Specialist equipment is needed to use this machine in demolition work. Before using it please contact your KOBELCO dealer.  
Due to our policy of continuous product improvements all designs and specifications are subject to change without advance notice.  
Copyright by **KOBELCO CONSTRUCTION MACHINERY CO., LTD.** No part of this catalogue may be reproduced in any manner without notice.

---

**KOBELCO CONSTRUCTION MACHINERY CO., LTD.**

5-15, Kitashinagawa 5-chome, Shinagawa-ku, Tokyo 141-8626 JAPAN  
Tel: +81 (0) 3-5789-2146 Fax: +81 (0) 3-5789-2135  
[www.kobelcocm-global.com](http://www.kobelcocm-global.com)

Enquiries To:

SK30SR/SK35SR-7-ANZ-101-2310XXEF