

**KOBELCO**

**SK210D**

**Multi-Dismantling Machine**



**We Save You Fuel**  
Achieving a Low-Carbon Society

# ELV Dismantling Business of the Future

**KOBELCO's multi-dismantling machines will drastically change the quantity and quality of end-of-life vehicle (ELV) recycling in Australia.**

The number of cars in the world has continued to grow and exceeded 1.3 billion cars in 2016. Accordingly, number of ELVs has increased to a point where recycling of cars has become an international issue. In Australia, the number of ELVs has surpassed 800,000 cars per year. The main focus of a car dismantling business was previously the resale of parts but is now the internationalisation of used parts, and scrap markets continue to show opportunities for even greater growth. Furthermore, the value of ELV as a resource will continue to rise as the materials used for cars change by implementation of next generation technologies. Such possibilities for greater revenue include electric motors, secondary batteries, and other reusable parts and rare valuable materials used in computerisation parts. To take advantage of this, an increase in quantity and quality is required. Our new multi-dismantling machines enable the world's top class car dismantling with their increased efficiency to process more cars in the same time, while also being more precise and accurate to allow separation and collection of valuable rare materials.





JAPANESE QUALITY



**SK210D**

# A Machine that Embodies KOBELCO's 40 Years of Experience in Dismantling Sites.

A machine designed and built specifically for car dismantling

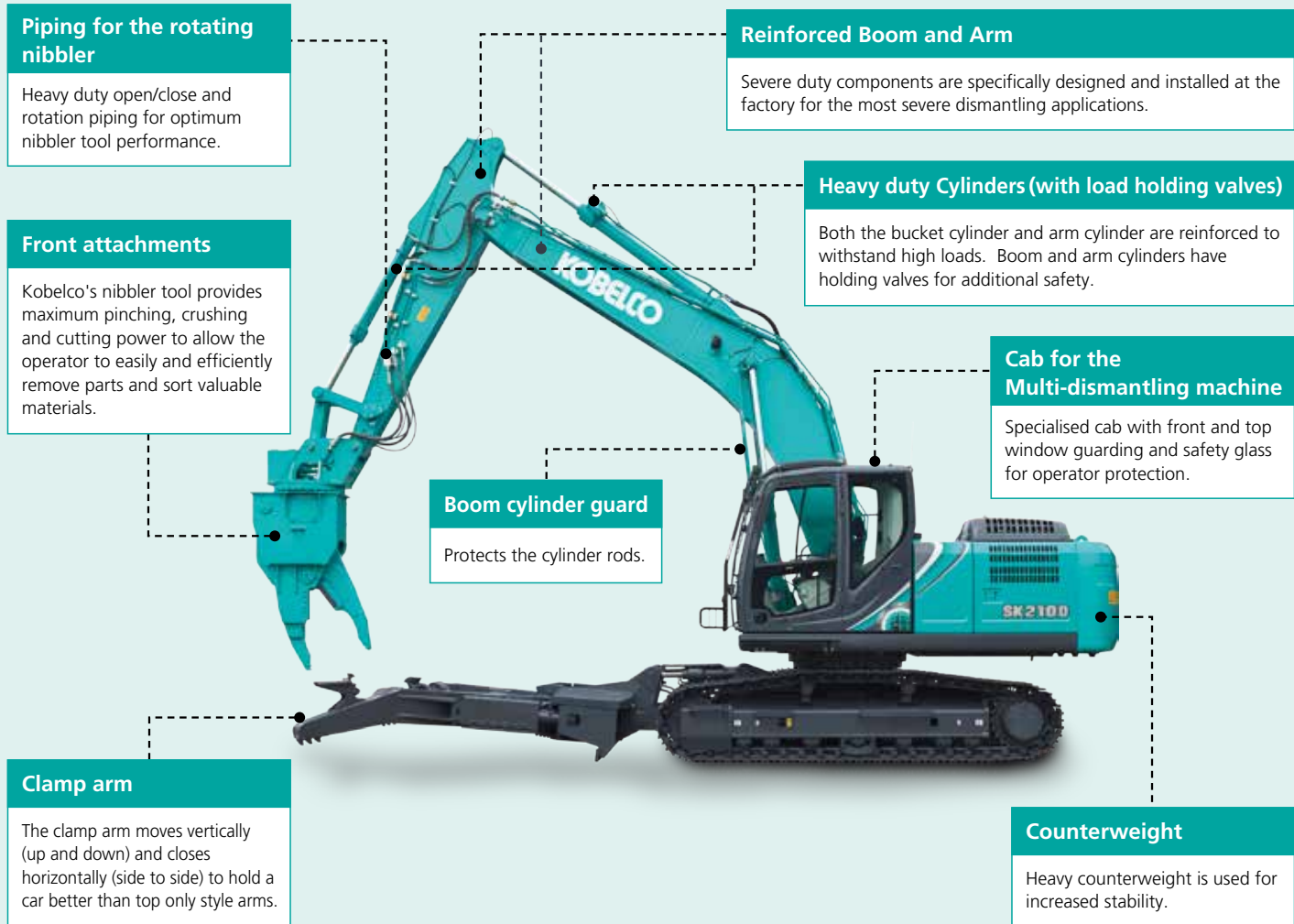

## Clamp arms

### Clamp arms specially designed by Kobelco

The Kobelco designed clamp arms are made to hold a vehicle in multiple positions to provide maximum access for complete dismantling. The clamp arms include additional tools to make the dismantling process quicker and more efficient.



#### Teeth

Used to separate aluminum heads and transmissions from engine blocks.



#### Puller

Used to remove instrument clusters and circuit boards and to clean wire and harnesses.



#### Grips

The bowl grips are used to hold the car for dismantling then used to hold smaller items like the engine and dash for additional parts removal.



#### Anchor

Designed to bend long objects easily.

## Overall flow of the car recycling process and the benefits of using multi-dismantling machines

### Dismantling process flow chart

How the Car Dismantling machine works

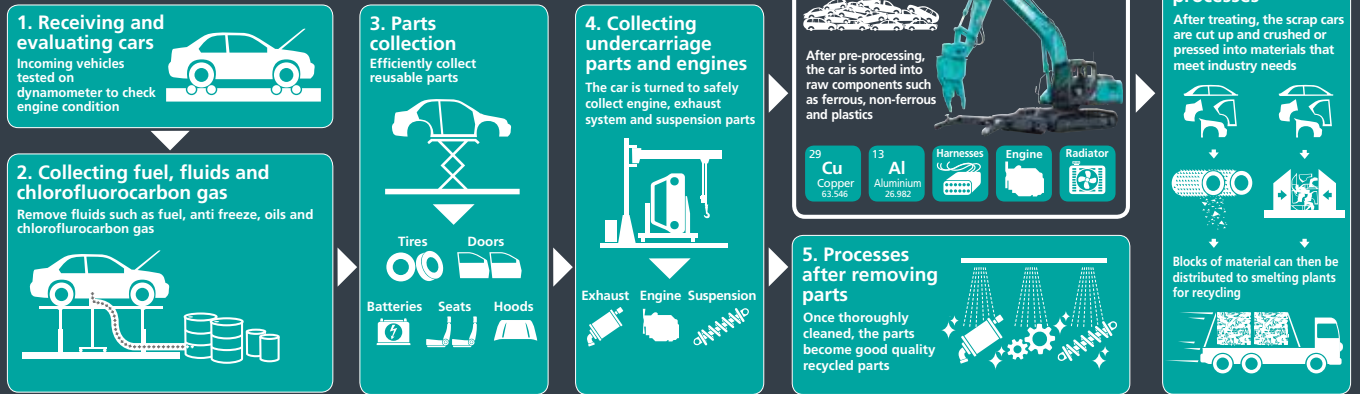

### The Evolution of the European car dismantling industry by Kobelco

Four times\* the vehicle dismantling capability compared with hand dismantling.

\*In one day (Kobelco test figures)

15 vehicles > One operative working by hand.

60 vehicles > One operative in a Kobelco Car Dismantling machine.

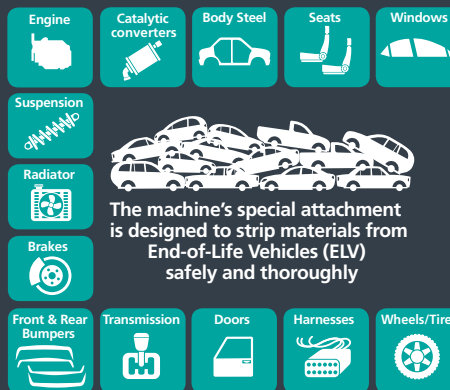

### Improved recovery rate of rare earth metals

26	13	29	78	46
Fe	Al	Cu	Pt	Pd
Iron	Aluminium	Copper	Platinum	Palladium
55.933	26.982	63.546	195.08	106.42

Separation of these valuable materials is quicker and easier and can be performed with one Kobelco machine.



## Front Attachments - Nibbler

### Specialised nibbler for more detailed separating processes

The Kobelco nibblers are designed to provide maximum gripping, holding, twisting, breaking and pulling power. Their heavy duty design is made to hold up to severe duty dismantling, yet they are nimble enough to perform delicate and precise operations. The tool has 2 rotation motors to provide additional rotation force for increased productivity to the customer.



Multi-dismantling nibbler KVE720PR

Heavy duty design and construction of the body, jaws, and pivot group allow for maximum production and ease of maintenance.

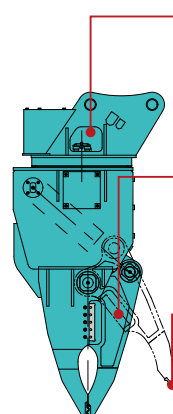

#### 360 degree rotating tool

Powerful rotation torque enables effective twisting and stripping motions via the proportionate control button on the left joystick. Movements are quick, controlled and precise.

#### Shear/cutter blades

The powerful shear/cutter blades at the back of the jar allow the operator to cut vehicle frames and chassis or downsize other materials.

#### Powerful crushing force

The interlocking replaceable teeth are made to grip and hold material securely, yet nimble enough to grab and pick up a single wire.

# Smooth and Efficient Operation, Thanks to Advanced Machine Design and Superior Technology

## Cab interference prevention system

The cab interference prevention system is provided as standard equipment to prevent the nibbler from contacting the cab during operation. Precise detection of the position and orientation of the nibbler minimises the interference warning range to enable a larger effective working area. Since the nibbler tool is restricted from coming into contact with the cab, the operator is able to work more productively and with more focus on the dismantling process.

### System operation

Audible and visual warnings appear when nibbler tool approaches the cab, but the machine stops it before it any contact to the cab is made.



### How it works

The system calculates the boom angle, arm angle, idler link motion angle to come up with the position and direction of the front attachment to control its motion.



Boom angle sensor



Arm angle sensor



Bucket angle sensor



## Comfortable operating environment

The large roomy cab has a wide open view through the large front and side windows. Posts are small and minimised to further reduce blind spots and distractions. The cab is also air tight, with inside and outside A/C filters and rides on suspension springs. All to keep the operator comfortable and productive.



Suspension seat absorbs vibration



Reclining seat has a wide recline angle

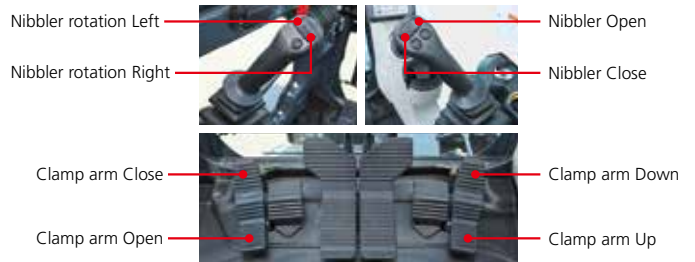

### Intuitive operation

Machine operation feels natural and is simplified by making the clamp arms operate by foot pedals and the nibbler by the joystick mounted rocker switches. Levers, pedals and switches are easily operable without requiring excessive force to prevent fatigue during extended periods of use.

## Environmentally Friendly Engine

### NOx emissions cut:

Environmentally friendly engine utilises SCR and a Diesel Particulate Filter (DPF) for emission control. In addition, it is equipped with large capacity DEF / AdBlue\* tanks to extend fill intervals.

\*AdBlue® is a registered trade mark of the Verband der Automobilindustrie e. V. (VDA).

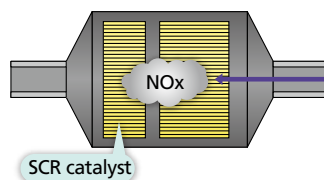

**At high temperatures, nitrogen and oxygen combine to produce nitrous oxides (NOx). Reducing the amount of oxygen and lowering the combustion temperature results in much less NOx.**

### EGR cooler

While ensuring sufficient oxygen for combustion, cooled emission gases are mixed with the intake air and recirculated into the engine. This reduces oxygen content and lowers combustion temperature.

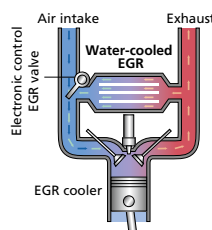

### PM emissions cut:

**Particulate matter (PM) is mostly soot resulting from incomplete combustion; improved combustion efficiency reduces PM emissions.**

### Common rail system

High-pressure injection atomises the fuel, and more precise injection improves combustion efficiency. This also contributes to better fuel economy.

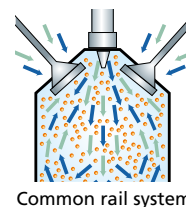

## Colour Multi-display

### Colour Multi-display

Brilliant Colours differentiate multiple graphics on the cab LCD screen. Graphics indicate fuel consumption, maintenance intervals and more.



Cab interference prevention alarm    Fuel consumption    Maintenance

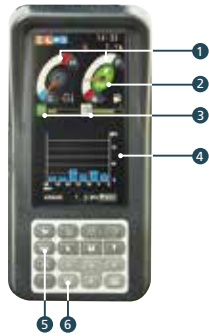

- 1 Analog-style gauges provide an intuitive reading of fuel level and engine temperature
- 2 Green indicates ECO-mode selected or efficient operation in other modes
- 3 PM accumulation (left) / DEF level (right)
- 4 Fuel consumption/Rear-view camera
- 5 Digging mode switch
- 6 Monitor display switch

## Energy-efficient System

### ECO-mode: engineered for economy

Kobelco's ECO-mode maximises the operating efficiency of the engine and other components to achieve much greater fuel efficiency. Just press a button to choose the operation mode best suited to the task at hand and the working conditions.

■ Optimal operation with three modes

- H** H-mode . . . Maximum power for maximum productivity on your toughest jobs
- S** S-mode . . . Ideal balance of productivity and fuel efficiency for a range of urban engineering projects
- E** ECO-mode . . . Minimum fuel consumption for utility projects and other work that demands precision

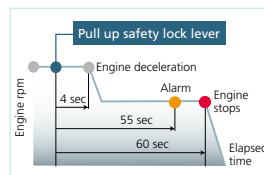

### AIS (Auto Idle Stop)

If the boarding/disembarking lever is left up, the engine will stop at a predetermined time automatically. This eliminates wasteful idling during standby, saving fuel and reducing CO<sub>2</sub> emissions as well.

■ Safety comes standard with KOBELCO, with equipment that allows operators to focus on the job at hand.



### Front guard (Vertical guard)

Front windows are protected by a vertical guard to prevent damage and provide additional safety for the operator.



### Top guard level 2 (Meets ISO10262)

The standard grid type cab ceiling guard protects the operator against objects falling on the cab roof.



### Front window

Front and right side window have tear and penetration-resistance film to hold glass fragments together.



### Rear-view camera

Standard machine safety feature to protect the operator, personnel around the machine, and surrounding equipment.



### Cab entry step

The larger step makes it easy for the operator to climb into and out of the cab.



### Lower frame step

An additional step is installed on the side of the crawler frame.



### Public address system

Operator is able to alert ground workers without taking their hands off the machine controls.



### Travel alarm

The alarm cautions workers in the area that the machine is traveling.



### Cab with two LED lights

Highly bright long-life LED lights are equipped as standard working lights.



### Boom with two lights

Working lights are equipped as standard on both sides of the boom.



### Heavy Counterweight

A special heavy counterweight ensures substantial stability, making it easier to grab and raise heavy objects such as end-of-life vehicles.

# Our Long-Life Philosophy of Maintaining Long-term Performance

## Body frame designed for improved strength

\*Green areas represent components of the specialized design.

These machines have reinforced frames and specially designed swing areas due to the heavier counterweight and clamp arms. These reinforcements are made when the machine is manufactured to ensure durability and longevity. Since Kobelco has been building and refining dismantler machines for over 40 years, they know what stresses the machine can go through. By addressing these areas from the start, it avoids the breakdowns and repairs that are seen on competitive lighter duty units.



Frame is reinforced from the factory to support the heavier counterweight.

Upper frame



Lower frame

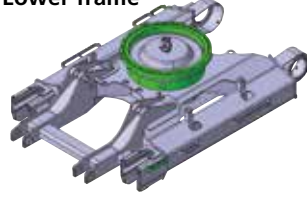

## Factory designed and installed rugged and durable attachments

\*Green areas represent components of the specialized design.

Thick steel plates have been added to the heavy duty arm right, left, and front sides of the boom to resist twisting. The sides and back of arms are reinforced with thick plates, and there is a rock guard added to the end of the arm to further reinforce and protect it from damage.



High-strength multi-dismantling attachment

HD arm

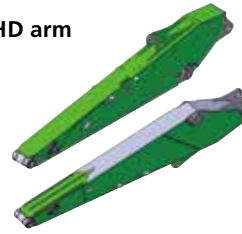

HD boom



## Purpose-built structures maximise durability while reducing maintenance costs.



Boom cylinder guards

Guided reinforced boom cylinder guard with box-type structure



Dismantling arm cylinder

Heavy duty arm cylinder made specifically for dismantling application.



Dismantling bucket cylinder

Use of a dedicated cylinder with heavy duty components.



Boom & arm holding valves

Standard - to prevent boom or arm from falling if hose is damaged.



Upper frame under cover guards

Upper frame belly guards. Reinforced guarding to protect the engine, hydraulic system and operator station.



Swivel guard

Heavy duty guarding for hydraulic components in the swivel / swing area.



Dust-proof fuel tank cap

The fuel cap is lined with rubber to prevent dust from contaminating the fuel tank.



Work boot tray

The operator is able to put dirty work boots in the outside tray to help keep the cabin clean.



Removable screens for easy cleaning

Easily removable screens to prevent material from clogging the cooling system.



Hydraulic oil filter

Glass filtration material with outstanding cleaning ability and durability is used.



Maintenance space

The upper space provides a comfortable platform for maintenance inside the engine hood.





SK210D

# GEOSCAN Excavator Remote Monitoring System

## Total Support for Machines with Network Speed and Accuracy

GEOSCAN is a satellite-based system for receiving machine information. Manage your machines anywhere in the world using the internet. Location, workload and diagnostic data aid business operations.

### Direct Access to Operational Status

#### Location Data

Accurate location data can be obtained even from sites where communication is difficult.

#### Operating Hours

A comparison of operating times of machines at multiple locations shows which locations are busier and more profitable. Operating hours on site can be accurately recorded, for running time calculations needed for rental machines, etc.

#### Fuel Consumption Data

Data on fuel consumption and idling times can be used to indicate improvements in fuel consumption.

#### Graph of Work Content

The graph shows how working hours are divided among different operating categories, including digging, idling, traveling, and optional operations (N&B).



### Maintenance Data and Warning Alerts

#### Machine Maintenance Data

Provides maintenance status of separate machines operating at multiple sites. Maintenance data is also relayed to KOBELCO service personnel, for more efficient planning of periodic servicing.

### Security System

#### Engine Start Alarm

Sends a notification if the engine is started outside of pre-defined hours.

#### Area Alarm

Sends a notification if the machine leaves a pre-defined area.



## Engine

Model	HINO J05EUM-KSSC
Type	Direct injection, water-cooled, 4-cycle diesel engine with turbocharger, intercooler
No. of cylinders	4
Bore and stroke	112 mm x 130 mm
Displacement	5.123 L
Rated power output	119 kW / 2,000 min <sup>-1</sup> (ISO 9249 : with fan)
	124 kW / 2,000 min <sup>-1</sup> (ISO 14396 : without fan)
Max. torque	640 N-m / 1,600 min <sup>-1</sup> (ISO 9249 : with fan)
	660 N-m / 1,600 min <sup>-1</sup> (ISO 14396 : without fan)



## Hydraulic System

Pump	
Type	Two variable displacement piston pumps + one gear pump
Max. discharge flow	2 x 220 L/min 1 x 20 L/min
	Extra gear pump 1 x 50 L/min
Relief valve setting	
Excavating circuits (main)	34.3 MPa
Travel circuit	34.3 MPa
Swing circuit	29.0 MPa
Pilot control circuit	5.0 MPa
Nibbler (Crusher) circuit	Open & Close 29.4 MPa Rotation 20.6 MPa
Clamp arm circuit	Open & Close 24.5 MPa Up 29.4 MPa / Down 37.8 MPa
Main control valve	8-spool
Oil cooler	Air cooled type



## Swing System

Swing motor	axial piston motor
Parking brake	Oil disk brake, hydraulic operated automatically
Swing speed	12.7 min <sup>-1</sup>
Swing torque	71.5 kN-m
Tail swing radius	2,910 mm
Min. front swing radius	3,540 mm



## Travel System

Travel motors	2 x axial piston, two-speed motors
Parking brakes	Oil disk brake per motor
Travel shoes	46 pads (each side)
Travel speed	6.0 / 3.6 km/h
Drawbar pulling force	229 kN (SAE J 1309)
Gradeability	57 % {30°}



## Refilling Capacities & Lubrications

Fuel tank	320 L
Cooling system	18 L
Engine oil	20.5 L
Travel reduction gear	2 x 5 L
Swing reduction gear	3 L
Hydraulic oil tank	140 L tank oil level
	300 L hydraulic system
DEF/AdBlue tank	83 L

## Operating Weight & Ground Pressure

Shoe width	600 mm
Ground pressure	67 kPa
Operating weight	30,100 kg



## Front Attachments

Model	KVE720PR
Weight	1,950 kg
Shearing force (blade center)	539 kN
Crushing force (tooth-jaw tip)	196 kN
Operating pressure	open / close 29.4 MPa
	rotation 20.6 MPa

### Nibbler

Unit : mm

Multi-dismantling nibbler KVE720PR

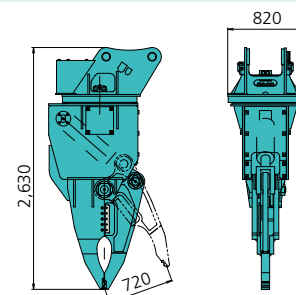



## Dimensions

Unit : mm

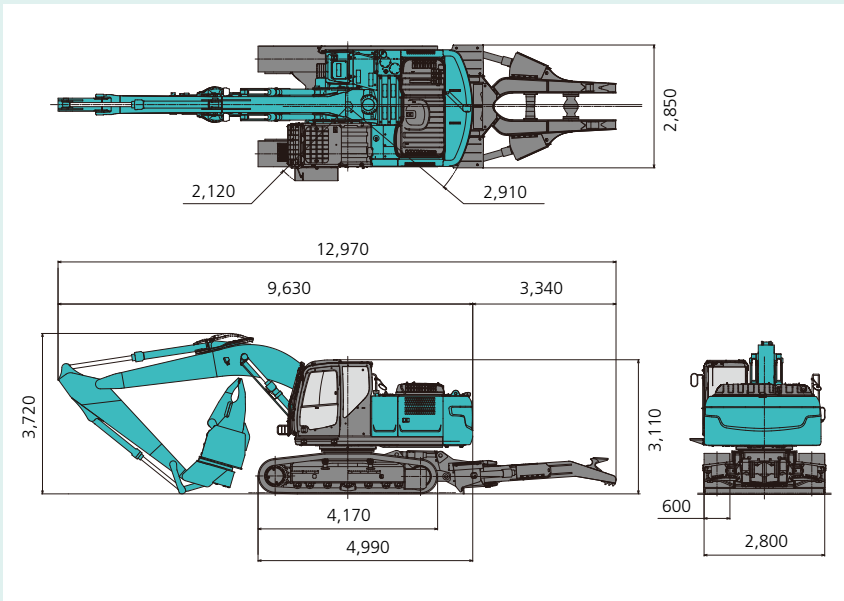

## Working Ranges

Unit : mm

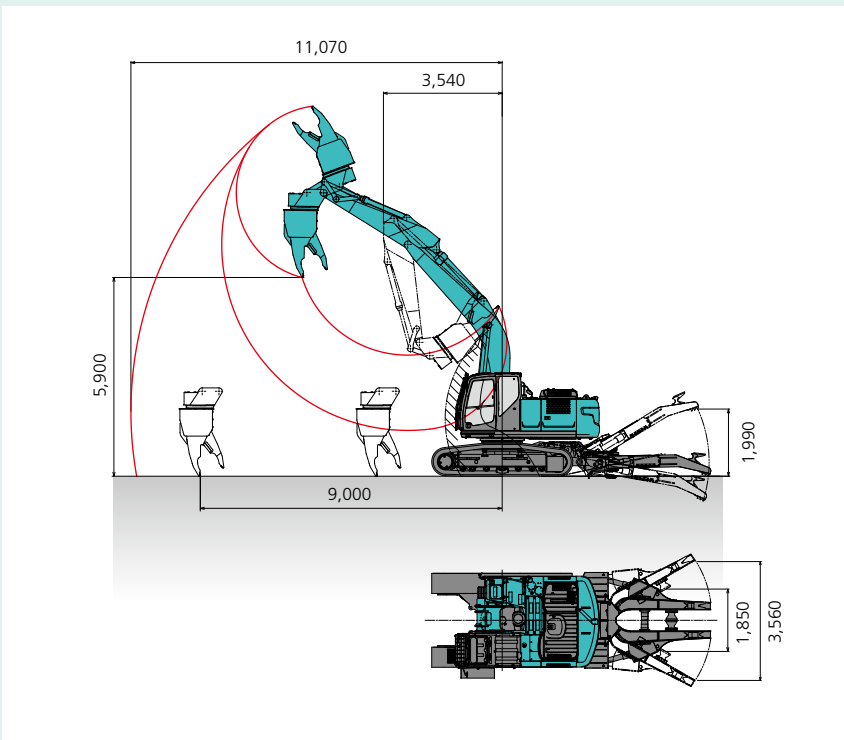

## STANDARD EQUIPMENT

### ENGINE

- HINO J05EUM-KSSC diesel engine with turbocharger and intercooler
- Two 12 Volt 96Ah batteries
- 24V-5kW starter
- 60-amp alternator
- Automatic engine deceleration
- Proportionate engine accelerate
- Removable clean out screen
- Double element air cleaner
- Automatic low engine oil pressure shut down
- Side by side oil, hydraulic and engine radiators

### HYDRAULIC

- Hydraulic oil cooler
- Hydraulic oil filter condition indicator
- Rotation and N&B auxiliary circuits and piping

### SWING SYSTEM & TRAVEL SYSTEM

- Swing rebound prevention system
- Two-speed travel with automatic shift down
- Sealed & lubricated track links
- Flat shoes
- Grease-type track adjusters
- Automatic swing brake

### MIRRORS, LIGHTS & CAMERA

- Two rearview mirrors
- Rear-view camera
- Three front working lights (1 on upper carriage, 2 on cab)
- Two attachment front working lights
- Swing flashers with 2 rear work lights

### CAB & CONTROL

- Two control levers, pilot-operated
- Electric horn and travel alarm
- Cab light (interior)
- Large cup holder
- Detachable two-piece floor mat
- Air suspension seat with armrests
- Cab entry and engine access handrails
- Heater and defroster
- Intermittent windshield wiper with double-spray washer

- Sky light
- Front guard (vertical bars type 2-face guard)
- Top guard level II (Meets ISO10262)
- Tinted safety glass and shatterproof film
- Pull-type front window and removable lower front window
- Easy-to-read multi-display monitor
- Automatic air conditioner
- Emergency escape hammer
- Radio, AM/FM Stereo with speakers
- 12V power source
- AUX, USB, Bluetooth
- Cab entry step

- Boom&arm holding valve
- Cab interference prevention system
- 9mm thick swivel guard
- 6mm thick upper frame under coverguards
- Reinforced travel motor covers
- Boom cylinder guards
- Work boot tray
- Public address system
- GEOSCAN
- Heavier counter weight (+1,670kg)

## OPTIONAL EQUIPMENT

- Front screen (mesh type 2-face guard)
- Track shoes
- Right side camera, additional monitor
- Polycarbonate guard (Must be installed with bar guard)

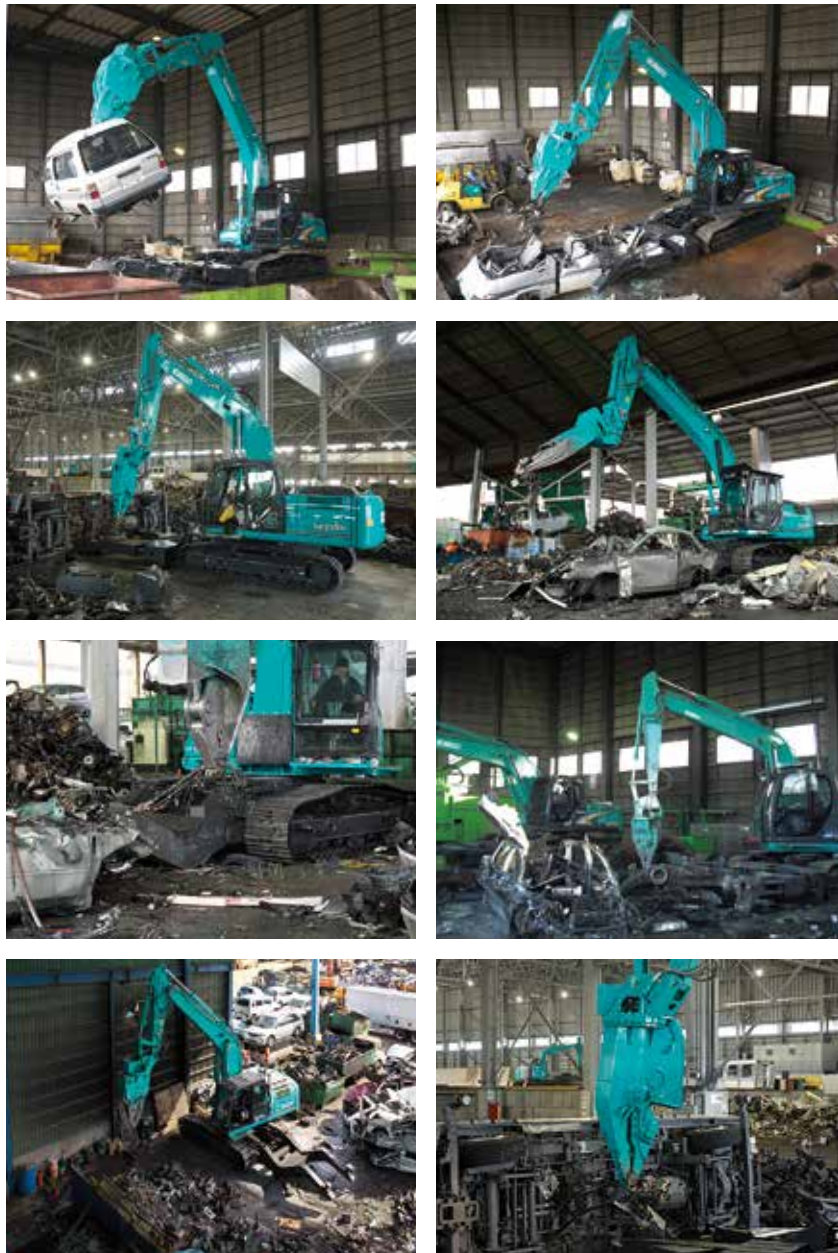

Note: This catalog may contain attachments and optional equipment that are not available in your area. And it may contain photographs of machines with specifications that differ from those of machines sold in your areas. Please consult your nearest KOBELCO distributor for those items you require. Specialist equipment is needed to use this machine in demolition work. Before using it please contact your KOBELCO dealer. Due to our policy of continuous product improvements all designs and specifications are subject to change without advance notice. Copyright by **KOBELCO CONSTRUCTION MACHINERY CO., LTD.** No part of this catalog may be reproduced in any manner without notice.

**KOBELCO CONSTRUCTION MACHINERY CO., LTD.**  
5-15, Kitashinagawa 5-chome, Shinagawa-ku, Tokyo 141-8626 JAPAN  
Tel: +81 (0) 3-5789-2146 Fax: +81 (0) 3-5789-2135  
<https://www.kobelcocm-global.com/>

Inquiries To: