

KOBELCO

SK380XDLC-10

SK380XD^{LC}

■ **Bucket Capacity :**

1.20 – 1.60 m³ (ISO heaped)

■ **Engine Power :**

209 kW / 2,100 min⁻¹ (ISO 14396)

■ **Operating Weight :**

37,700 – 38,900kg



We Save You Fuel
Achieving a Low-Carbon Society

Extra Heavy Duty

Built for the most extreme work environments, KOBELCO XD Series excavators feature a rugged machine body with comprehensive additional reinforcement across the boom, arm and undercarriage, for a machine that will stand up to the most demanding work.

Built to KOBELCO's world renowned standards of Japanese quality and reliability, it all adds up to KOBELCO's toughest heavy excavator ever.

KOBELCO's advanced hydraulic technology delivers the ultimate in power and efficiency, giving you uncompromising performance, while delivering KOBELCO's proven low fuel consumption to benefit your bottom line.

The SK380XDLC has been built to meet the needs of the most punishing sites with superior digging performance and productivity that simply astounds.





Quick hitch piping and top guard are equipped as standard.

Next-Level Strength & Durability

Reinforced Arm Exhibits Strength

Thick steel plate **NEW**



Arm top

Thickness of steel plate has been increased in preference to adding reinforcing plates.



Arm foot

Base plate thickness has been increased.

Modified Foot Boss Shape



The arm foot boss shape has been modified and improved to distribute stress, delivering more strength for tasks like digging next to a wall.

Rock Guards **NEW**

Specially designed long, solid rock guard installed to prevent damage to arm.





Get More Done Faster with Superior Operability

Piping for Quick Hitch

A quick hitch hydraulic line, which speeds up attachment changes, is fitted as standard.



Newly Developed Mining Boom Made of Thicker Steel Plate

Featuring an XD Boom **NEW**

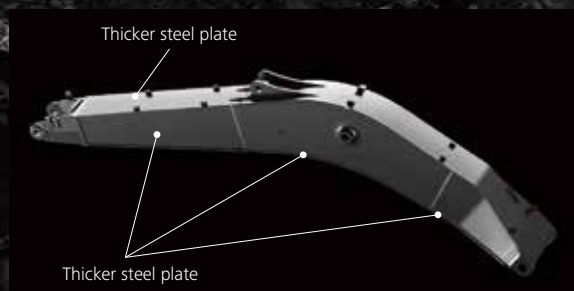

The XD boom features stronger plates compared to the HD booms of standard machines, which increases longevity even under the toughest working conditions.

Big Cross-Section Boom **NEW**



Newly designed, big cross-section boom for unbeatable durability under harsh working conditions.

Side Deck Bumpers and Protective Guards that Cover the Main Upper Machinery

Side Deck Bumpers

Side deck bumpers are fitted to protect power plant.



Upper Under Covers **NEW**

Thick covers with increased durability compared to standard models.



Quick hitch piping and top guard are equipped as standard.

Power Meets Efficiency for Increased Productivity

"Power" means increased productivity

Best-in-class drawbar pull delivers powerful tractive force, for easy transit over loose stones, while a highly reliable filtration system results in superior hydraulic performance for the life of the machine.

An Undercarriage Built for Unbeatable Durability

Reinforced Guide Frame **NEW**



Reinforced guide frame prevents deformation caused by impact or encroaching of loose stones.

Reinforced Step **NEW**



Design of the step uses strong, thick-plate steel, to stop large rocks impacting the travel motor.

Track Guides **NEW**



Large, reinforced track guides are installed in three locations.

Thicker Steel Plate for Shoes **NEW**



Reinforced HD shoes of thick steel plate to master rough, stony ground.

Track Links **NEW**



The size and durability of the track link are increased compared to standard models.

Reinforced Travel Motor Cover **NEW**



Rear of travel motor cover is reinforced.

Lower Frame Underside Cover **NEW**



Hydraulic piping and equipment protected against damage from rubble and stony ground.



Improved Filtration System Reliability

Clean, contaminant-free fuel and hydraulic fluid are essential to stable performance. The improved filtration systems reduce the risk of mechanical trouble and enhance longevity and durability.

Fuel Filter

The pre-filter with built-in water separator has 1.8 times more filter area compared to the previous models and with a new final stage maintenance free fuel filter to maximise filtering performance.

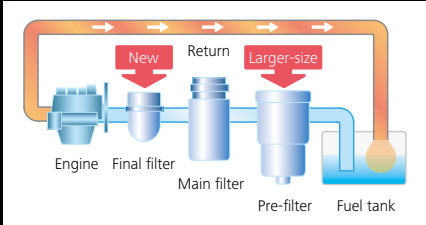

Hydraulic Fluid Filter

Recognised as the best in the industry, our Premium-fine filter separates out even the smallest particles. A new cover prevents contamination when changing filters.

Metal Mesh Cover Air Cleaner

Metal mesh cover ensures strength and durability.

Hydraulic Fluid Filter Clog Detector

Hydraulic tank pressure sensor monitors the pressure difference between the return line and tank inside pressure to determine the degree of clogging. If the difference exceeds a predetermined level, a warning appears on the multi-display, so any contamination can be trapped by the filter and replaced before it reaches the hydraulic fluid in the tank.

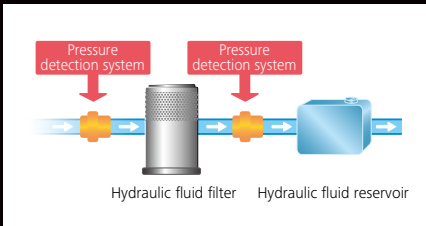

Proven Reliability and Improved Fuel Efficiency

"Efficiency" means proven low fuel consumption

The new arm interflow system more efficiently controls hydraulic fluid flow, and delivers a significant reduction of in-line resistance and pressure loss. This improves fuel efficiency.



Hydraulic System: Revolutionary Technology Saves Fuel

Arm Interflow System

When lowering the boom, this system uses the downward force generated by the boom's weight to push fluid to the shovel arm. This greatly reduces the need to apply power from outside the system.

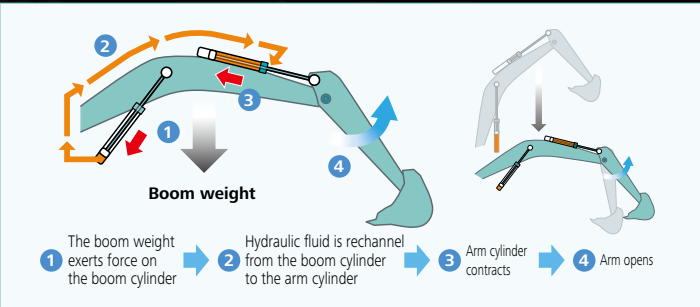

In Pursuit of Improved Fuel Efficiency

Operation Mode

Fuel consumption is lower in ECO-mode/H-mode/S-mode in comparison with the previous model (SK330-8).



- E** Minimum fuel consumption for utility projects and other work that demands precision
ECO-mode, 24% decrease
- H** Used to prioritise amount of work done
H-mode, 16% decrease
- S** Used to strike a balance between workloads and fuel efficiency
S-mode, 19% decrease



Get More Output Faster with Superior Performance

Standard 3.30 m arm (reinforced for rocks)

- | | |
|---------------------------------|--------------------------------|
| ■ Max. Bucket Digging Force | ■ Max. Digging Reach: |
| Normal: 222 kN | 11,260 mm |
| With Power Boost: 244 kN | ■ Max. Digging Depth: |
| | 7,560 mm |
| ■ Max. Arm Crowding Force | ■ Max. Vertical Digging Depth: |
| Normal: 163 kN | 6,610 mm |
| With Power Boost: 180 kN | |

Top Class Tractive Force

Powerful tractive force and drawbar pulling force deliver plenty of speed when climbing slopes or negotiating rough terrain, and the agility to change direction swiftly and smoothly.

- Drawbar Pulling Force: **331 kN**



Pursuing Maximum Fuel Efficiency

AIS (Auto Idle Stop)

If the boarding/disembarking lever is left up, the engine will stop automatically. This eliminates wasteful idling during standby, saving fuel and reducing CO₂ emissions as well.

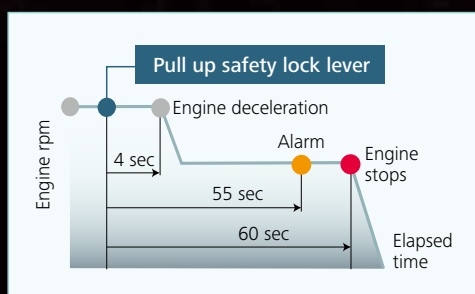

Common Rail System

High-pressure injection atomises the fuel, and more precise injection improves combustion efficiency. This also contributes to better fuel economy.

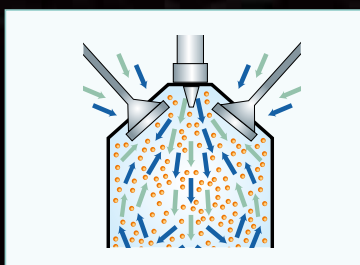

EGR Cooler

While ensuring sufficient oxygen for combustion, cooled emission gases are mixed with the intake air and recirculated into the engine. This reduces oxygen content and lowers combustion temperature.

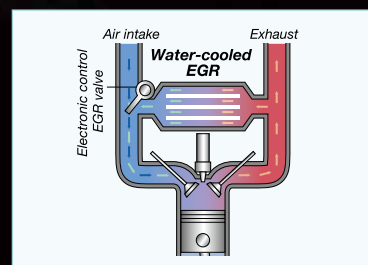

Quick hitch piping and top guard are equipped as standard.

A Cabin Designed for Operator Comfort and Visibility

A work environment that is quieter and more comfortable. A cab that puts the operator first is key to improved productivity.



Air Conditioner Vents behind the Seat



The large air-conditioner has louvers on the back pillars that blow from behind and to the right and left of the operator's seat. They can be adjusted to put a direct flow of cool/warm air on the operator, which means a more comfortable operating environment.

Super-Airtight Cab



The high level of air-tightness keeps dust out of the cab.

Low Vibration

Coil springs absorb small vibrations, and high suspension mounts filled with silicone oil reduce heavy vibration. The long stroke achieved by this system provides excellent protection from vibration.

Twice the stroke of a conventional mount

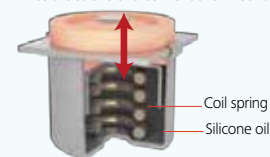

Multi-Display in Colour

Brilliant colours and graphic displays are easy to recognise on the LCD multi-display in the console. The display shows fuel consumption, maintenance intervals, and more.



Fuel consumption

MAINTENANCE
13.8h

INTERVAL	THRESHOLD	EXCHANGE DATE
ENGINE OIL	500	498
FUEL FILTER	500	498
HYD. FILTER	1000	998
HYD. OIL	5000	4998

Maintenance



Breaker mode

- 1 Analog gauge provides an intuitive reading of fuel level and engine water temperature
- 2 Green indicator light shows low fuel consumption during operation

- 3 Fuel consumption/Switch indicator for rear camera images
- 4 Digging mode switch
- 5 Monitor display switch

One-Touch Attachment Mode Switch

A simple touch of a button, switches the hydraulic circuit and flow amount to match attachment changes. Icons help the operator to confirm the proper configuration at a glance.

Comfort



The grips in this photo are not for this area.

Clear View Helps the Operator

The front window features one large piece of glass without a center pillar on the right side for a wide, unobstructed view.

Large Cab Is Easy to Get In and Out of

The expanded cab provides plenty of room for a large door, more headroom and smoother entry and exit.



More Comfortable Seat Means Higher Productivity



Seat suspension absorbs vibration



Seat recliner can be pushed back flat

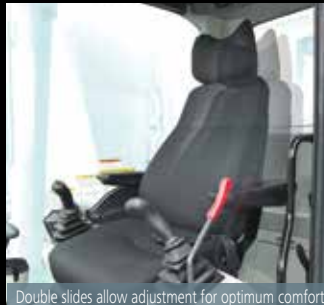

Double slides allow adjustment for optimum comfort

A Light Touch on the Lever Means Smoother, Less Tiring Work



Pilot controlled joysticks have 25% lower lever effort*, which reduces fatigue over long working hours or continued operations.

*Compared to SK500LC-9

Interior Equipment Adds to Comfort and Convenience



USB connector/12V power outlet



Large cup holder



AM/FM Bluetooth®(hands-free) radio

Safety

ROPS Cab

ROPS (Roll-Over-Protective Structure)-compliant cab clears ISO standards (ISO-12117-2: 2008) and ensures greater safety for the operator should the machine tip over.



TOP Guard is fitted as standard.

Expanded Field of View for Greater Safety



Rearview mirrors left and right

Greater safety assured by rearview mirrors on left and right.

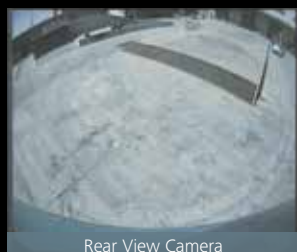

Rear View Camera



A rear view camera is installed as standard to simplify checking for safety behind the machine. The picture appears on the colour monitor.



Hammer for emergency exit

Efficient Maintenance Keeps the Machine in Peak Operating Condition



Examples of displaying maintenance information

Machine Information Display Function

- Displays only the maintenance information that's needed, when it's needed
- Self-diagnostic function provides early-warning detection and display of electrical system malfunctions
- Service-diagnostic function makes it easier to check the status of the machine
- Record function of previous breakdowns including irregular and transient malfunction

Easy, On-the-Spot Maintenance

There is ample space in the engine compartment for a mechanic to do maintenance work inside. The distance between steps is lower so entry and exit is easier. And the mechanic can work in comfort, without contortions or unnatural body positions. Finally, the hood is lighter and easier to raise and lower.



Generous space for maintenance work



Step/Hand rail

Daily Checks Made Simple, with Easy Ground Level Serviceability

The layout allows for easy access from the ground for many daily checks and regular maintenance tasks.



Double-element air cleaner

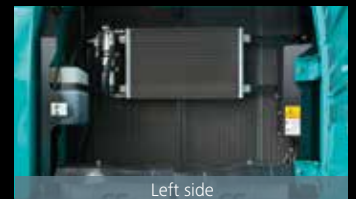

Left side

Simple layout for easy access to radiator and cooling system elements.

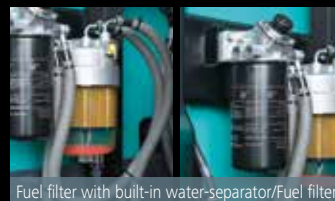

Fuel filter with built-in water-separator/Fuel filter

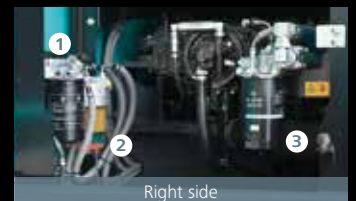

Right side

- 1 Fuel filter
- 2 Fuel filter with built-in water-separator
- 3 Engine oil filter

Easy Cleaning



Crawler frame

Special crawler frame design for easy mud removal cleaning.



Detachable two-piece floor mat

Detachable two-piece floor mat with handles for easy removal. A floor drain is located under floor mat.



Floor mat with raised edges

Floor mat has raised edges to help keep the cab floor free of mud, simplify cleaning.



Engine oil pan

Engine oil pan equipped with drain valve.

More Efficient Maintenance inside the Cab

Internal and external air conditioner filters can be easily removed without tools for cleaning.



Air conditioner filters

Specifications



Engine

Model	HINO J08ETM
Type	Direct injection, water-cooled, 4-cycle, 6-cylinder diesel engine with intercooler turbo-charger
No. of cylinders	6
Bore and stroke	112 mm X 130 mm
Displacement	7.684 L
Rated power output	197 kW/2,100 min ⁻¹ (ISO 9249 :with fan)
	209 kW/2,100 min ⁻¹ (ISO 14396: without fan)
Max. torque	969 N·m/1,600 min ⁻¹ (ISO 9249 :with fan)
	998 N·m/1,600 min ⁻¹ (ISO 14396: without fan)



Hydraulic System

Pump	
Type	Two variable displacement piston pumps + One gear pump
Max. discharge flow	2 x 294 L/min, 1 x 21 L/min Extra gear pump 1x43L/min
Relief valve setting	
Boom, arm and bucket	34.3 MPa
Power Boost	37.8 MPa
Travel circuit	34.3 MPa
Swing circuit	29.0 MPa
Control circuit	5.0 MPa
Pilot control pump	Gear type
Main control valves	8-spool
Oil cooler	Air cooled type



Swing System

Swing motor	Axial-piston motor
Brake	Hydraulic; locking automatically when the swing control lever is in neutral position
Parking brake	Oil disc brake, hydraulic operated automatically
Swing speed	10.0 min ⁻¹
Swing torque	122 kN·m



Attachments

Backhoe bucket and combination

Use	Backhoe bucket				
	Normal digging				
Bucket capacity	Heaped (ISO7451)	m ³	1.20	1.40	1.60
	Struck (ISO7451)	m ³	0.84	1.00	1.20
Opening width	With side cutter	mm	1,240	1,420	1,570
	Without side cutter	mm	1,110	1,300	1,450
No. of teeth			4	5	5
Bucket weight		kg	930	1,070	1,140
Combination	2.60 m short arm		○	○	◎
	3.30 m standard arm		○	◎	○

◎ Standard ○ Recommend



Travel System

Travel motors	2 x axial-piston, two-step motors
Travel brakes	Hydraulic brake per motor
Parking brakes	Oil disc brake per motor
Travel shoes	48 each side
Travel speed	5.6/3.3 km/h
Drawbar pulling force	331 kN (SAE)
Gradeability	70% {35°}



Cab & Control

Cab	
All-weather, sound-suppressed steel cab mounted on the high suspension mounts filled with silicone oil and equipped with a heavy, insulated floor mat.	
Control	
Two hand levers and two foot pedals for travel	
Two hand levers for excavating and swing	
Electric rotary-type engine throttle	



Boom, Arm & Bucket

Boom cylinders	140 mm x 1,550 mm
Arm cylinder	170 mm x 1,788 mm
Bucket cylinder	150 mm x 1,193 mm



Refilling Capacities & Lubrications

Fuel tank	503 L
Cooling system	35 L
Engine oil	28.5 L
Travel reduction gear	2 x 8.0 L
Swing reduction gear	7.0 L
Hydraulic oil tank	245 L tank oil level
	410 L hydraulic system

Specifications



Working Ranges

Unit: m

Boom	6.50 m	
Arm	Short 2.60 m	Standard 3.30 m
Range		
a- Max. digging reach	10.61	11.26
b- Max. digging reach at ground level	10.40	11.06
c- Max. digging depth	6.86	7.56
d- Max. digging height	10.26	10.58
e- Max. dumping clearance	7.06	7.37
f- Min. dumping clearance	3.32	2.62
g- Max. vertical wall digging depth	5.84	6.61
h- Min. swing radius	4.46	4.31
i- Horizontal digging stroke at ground level	4.21	5.82
j- Digging depth for 2.4 m (8') flat bottom	6.67	7.40
Bucket capacity ISO heaped m ³	1.60	1.40

Digging Force (ISO 6015)

Unit: kN

Arm length	Short 2.60 m	Standard 3.30 m
Bucket digging force	222 244*	222 244*
Arm crowding force	205 225*	163 180*

*Power Boost engaged.

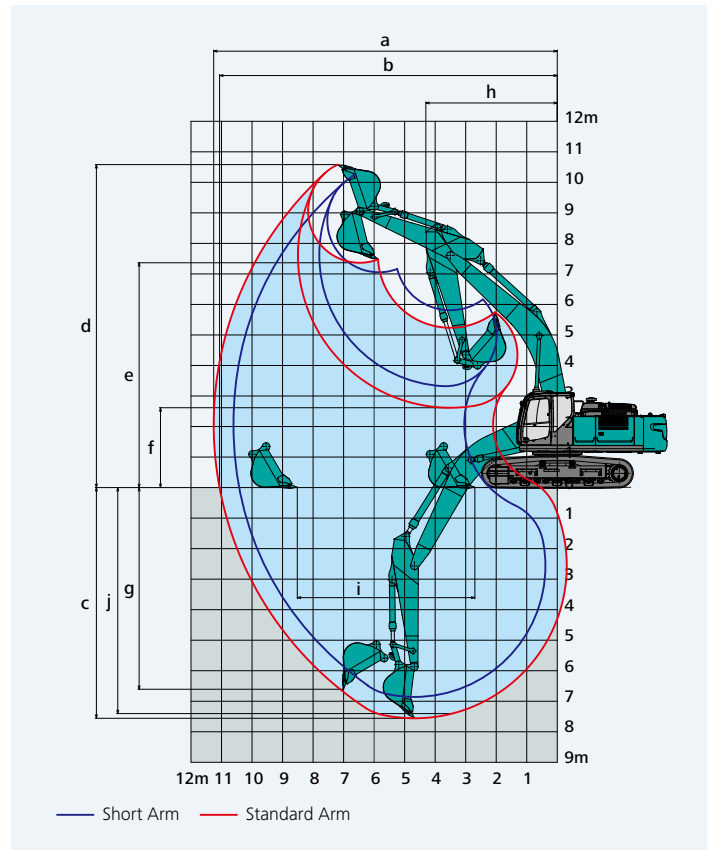

Dimensions

Arm length	Short 2.60 m	Standard 3.30 m
A Overall length	11,380	11,300
B Overall height (to top of boom)	3,690	3,430
C Overall width	3,260	
D Overall height (to top of cab)	3,220	
E Ground clearance of rear end*	1,210	
F Ground clearance*	500	

Unit: mm

G Tail swing radius	3,600
G' Distance from center of swing to rear end	3,600
H Tumbler distance	4,050
I Overall length of crawler	4,980
J Track gauge	2,590
K Shoe width	600
L Overall width of upperstructure	3,120

*Without including height of shoe.

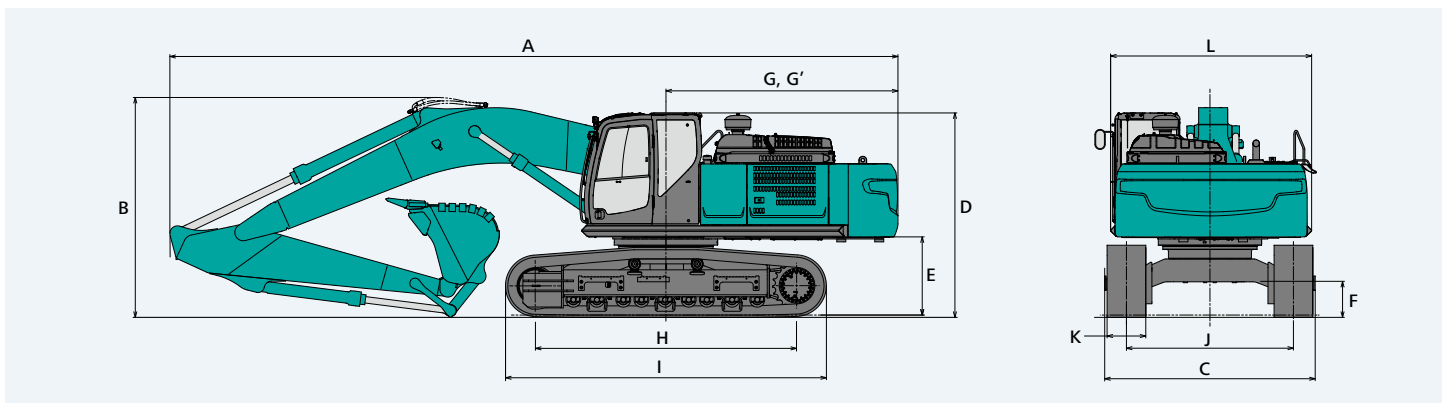

Operating Weight & Ground Pressure

In standard trim, with standard boom, 3.30 m arm, and 1.40 m³ ISO heaped bucket

Shaped		Triple grouser shoes		Double grouser shoes
Shoe width	mm	600	800	600
Overall width of crawler	mm	3,260	3,390	3,260
Ground pressure	kPa	71	55	71
Operating weight	kg	37,700	38,900	38,000

Lift Capacities

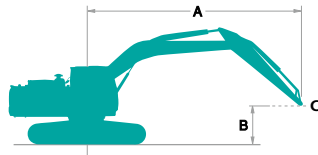

Rating over front



Rating over side or 360 degrees

A: Reach from swing centerline to arm top
 B: Arm top height above/below ground
 C: Lift point
 Relief valve setting: 37.8 MPa (385 kgf/cm²)

SK380XDLC		Boom: 6.5 m Arm: 2.6 m, Bucket: without Counterweight: 8,620 kg Shoe: 600 mm (Heavy Lift)										
B \ A	3.0 m		4.5 m		6.0 m		7.5 m		At Max. Reach		Radius	
7.5 m	kg									*8,730	*8,730	7.06 m
6.0 m	kg					*9,330	*9,330	*8,580	7,870	*8,510	7,040	8.00 m
4.5 m	kg			*13,410	*13,410	*10,430	*10,430	*8,990	7,630	*8,480	6,150	8.58 m
3.0 m	kg					*11,730	10,010	*9,610	7,310	*8,560	5,700	8.87 m
1.5 m	kg					*12,750	9,490	*10,160	7,030	8,660	5,550	8.89 m
G.L.	kg			*17,770	13,830	*13,180	9,210	*10,420	6,850	*8,890	5,680	8.66 m
-1.5 m	kg			*16,870	13,890	*12,890	9,150	*10,130	6,810	*9,050	6,160	8.15 m
-3.0 m	kg	*19,110	*19,110	*15,060	14,130	*11,680	9,300			*9,070	7,240	7.29 m
-4.5 m	kg	*14,510	*14,510	*11,690	*11,690					*8,560	*8,560	5.95 m

SK380XDLC		Boom: 6.5 m Arm: 3.3 m, Bucket: without Counterweight: 8,620 kg Shoe: 600 mm (Heavy Lift)														
B \ A	1.5 m		3.0 m		4.5 m		6.0 m		7.5 m		9.0 m		At Max. Reach		Radius	
9.0 m	kg													*6,340	*6,340	6.56 m
7.5 m	kg								*7,730	*7,730				*5,810	*5,810	7.86 m
6.0 m	kg								*7,840	*7,840				*5,610	*5,610	8.71 m
4.5 m	kg							*9,620	*9,620	*8,390	7,780	*7,760	5,800	*5,620	5,530	9.25 m
3.0 m	kg					*14,950	*14,950	*11,040	10,270	*9,130	7,430	*8,060	5,650	*5,800	5,160	9.52 m
1.5 m	kg					*17,140	14,410	*12,300	9,680	*9,830	7,110	*8,380	5,480	*6,160	5,020	9.54 m
G.L.	kg					*17,890	13,930	*13,030	9,290	*10,290	6,870	8,420	5,360	*6,790	5,110	9.33 m
-1.5 m	kg			*15,360	*15,360	*17,530	13,830	*13,100	9,140	*10,300	6,760			*7,850	5,460	8.85 m
-3.0 m	kg	*17,490	*17,490	*22,070	*22,070	*16,220	13,970	*12,360	9,180	*9,580	6,810			*8,530	6,230	8.07 m
-4.5 m	kg			*18,010	*18,010	*13,650	*13,650	*10,370	9,440					*8,440	7,900	6.88 m

Notes:

- Do not attempt to lift or hold any load that is greater than these lift capacities at their specified lift point radius and heights. Weight of all accessories must be deducted from the above lift capacities.
- Lift capacities are based on machine standing on level, firm, and uniform ground. User must make allowance for job conditions such as soft or uneven ground, out of level conditions, side loads, sudden stopping of loads, hazardous conditions, experience of personnel, etc.
- Arm top pin is defined as lift point.
- The above lift capacities are in compliance with ISO 10567. They do not exceed 87% of hydraulic lift capacity or 75% of tipping load. Lift capacities marked with an asterisk (*) are limited by hydraulic capacity rather than tipping load.
- Operator should be fully acquainted with the Operator's and Maintenance Instructions before operating this machine. Rules for safe operation of equipment should be adhered to at all times.
- Lift capacities apply to only machine as originally manufactured and normally equipped by KOBELCO CONSTRUCTION MACHINERY CO., LTD.

STANDARD EQUIPMENT

ENGINE

- Engine, HINO J08ETM, diesel engine with turbocharger and intercooler
- Automatic engine deceleration
- Auto Idle Stop (AIS)
- Batteries (2 x 12 V - 96 Ah)
- Starting motor (24 V - 5 kW), 50 amp alternator
- Automatic engine shut-down for low engine oil pressure
- Engine oil pan drain cock
- Double element air cleaner
- Battery shut down
- Pre air cleaner
- Emergency engine shut-off switch

CONTROL

- Working mode selector (H-mode, S-mode and ECO-mode)
- Power Boost
- Heavy Lift
- Boom and arm safety valve
- N&B piping
- Quick hitch piping

SWING SYSTEM & TRAVEL SYSTEM

- Swing rebound prevention system
- Straight propel system
- Two-speed travel with automatic shift down
- Sealed & lubricated track links
- Grease-type track adjusters
- 600 mm HD triple grouser shoe
- Lower under cover
- Travel alarm
- Automatic swing brake
- Track guides (3 on each side)

HYDRAULIC

- Arm interflow system
- Auto warm up system
- Aluminum hydraulic oil cooler
- Hydraulic fluid filter clog detector

MIRRORS & LIGHTS

- Two rear view mirrors
- Five front working lights
(Two for boom, one for right storage box and two for cab)
- Rear view camera

CAB & CONTROL

- Two control levers, pilot-operated
- Horn, electric
- Cab light (interior)
- Luggage tray
- Large cup holder
- Detachable two-piece floor mat
- Headrest
- Handrails
- Intermittent windshield wiper with double-spray washer
- Skylight
- Tinted safety glass
- Pull-up type front window and removable lower front window
- Easy-to-read multi-display colour monitor
- Automatic air conditioner
- Emergency escape hammer
- Air suspension seat
- 12 V outlet
- Radio (AUX & Bluetooth®)
- USB pin
- TOP guard (ISO 10262:1998)
- GEOSCAN

OPTIONAL EQUIPMENT

- 2.60 m SHD arm
- 600 mm HD double grouser shoe
- 800 mm HD triple grouser shoe
- Front guard
- Right side view camera
- Refilling pump
- Suspension seat
- Extra hydraulic circuit
- Rain visor
(may interfere with bucket action)

Note: Standard and optional equipment may vary. Consult your KOBELCO dealer for specifics. Bluetooth® is a registered trademark of the Bluetooth SIG Inc.

EXCAVATOR REMOTE MONITORING SYSTEM

The GEOSCAN Remote Monitoring System is a satellite and cellular based system for remotely monitoring machine information and managing routine maintenance. Manage your machines anywhere in the world, with location, workload, maintenance information and diagnostic data available 24/7 via the GEOSCAN website.

Direct Access to Operational Status

Location Data

Accurate location data can be obtained even from sites where communications are difficult.

Operating Hours

A comparison of operating times of machines at multiple locations shows which locations are busier and more profitable.

Operating hours on site can be accurately recorded, for running time calculations needed for rental machines, etc.

Fuel Consumption Data

Data on fuel consumption and idling times can be used to indicate improvements in fuel consumption.

Graph of Work Content

The graph shows how working hours are divided among different operating categories, including digging, idling, traveling, and hydraulic attachment use.



Maintenance Data and Warning Alerts

Machine Maintenance Data

Provides maintenance status of separate machines operating at multiple sites.

Maintenance data is also relayed to KOBELCO service personnel, for more efficient planning of periodic servicing.

Security System

Engine Start Alarm

Sends a notification if the engine is started outside of pre-defined hours.

Area Alarm

Sends a notification if the machine leaves a pre-defined area.

Note: Remote monitoring system is not applicable in some area due to country regulation of the communication lines or availability of infrastructure.

Note: This catalog may contain attachments and optional equipment that are not available in your area. And it may contain photographs of machines with specifications that differ from those of machines sold in your areas. Please consult your nearest KOBELCO distributor for those items you require. Due to our policy of continuous product improvements all designs and specifications are subject to change without advance notice.

Copyright by KOBELCO CONSTRUCTION MACHINERY CO., LTD. No part of this catalog may be reproduced in any manner without notice.

KOBELCO CONSTRUCTION MACHINERY CO., LTD.

5-15, Kitashinagawa 5-chome, Shinagawa-ku, Tokyo 141-8626 JAPAN
Tel: +81 (0) 3-5789-2146 Fax: +81 (0) 3-5789-2135
www.kobelcocm-global.com

Inquiries To: