

# KOBELCO

## SK850<sub>LC</sub>

■ Bucket Capacity :

2.3 - 5.1 m<sup>3</sup>

■ Engine Power :

380 kW / 1,800 min<sup>-1</sup>

■ Operating Weight :

79,400 kg - 88,000 kg



**We Save You Fuel**  
Achieving a Low-Carbon Society



**KOBELCO**

**SK850<sub>LC</sub>**

Higher  
efficiency,  
low fuel  
consumption

More power  
for increased  
productivity

From urban centres to mines around the world, Kobelco's advanced hydraulic technology delivers the ultimate in power and efficiency, giving you uncompromising performance while delivering Kobelco's proven low fuel consumption, to benefit your bottom line. The Kobelco SK850LC has been built to meet the needs of the most demanding worksites around the globe, with superior digging performance and next-generation productivity and reliability ensuring a low total cost of ownership.



# Proven Reliability and Improved Fuel Efficiency.

## Hydraulic System: Revolutionary Technology Saves Fuel

### Hydraulic Circuit Reduces Energy Loss

We have made every effort to enhance fuel efficiency by minimising hydraulic pressure resistance, improving the hydraulic line layout to control friction resistance loss and minimising valve resistance.

Improved hydraulic piping is an effective means of reducing pressure loss.

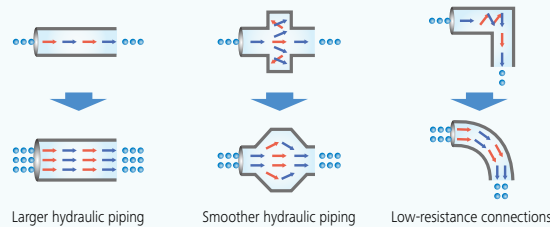

## Revolutionary technology boosts efficiency and minimises fuel consumption

### Operation Mode

■ Optimal operation with three modes

**H** **H-mode** ••••• Maximum power for maximum productivity on your toughest jobs

**S** **S-mode** ••••• Ideal balance of productivity and fuel efficiency for a range of urban engineering projects

**E** **ECO-mode** ••• Minimum fuel consumption for utility projects and other work that demands precision

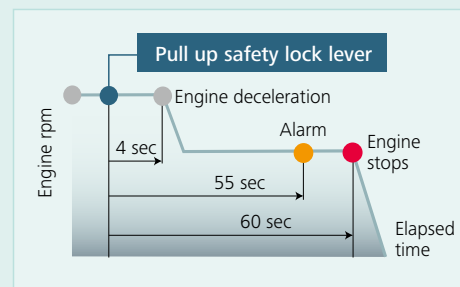

### AIS (Auto Idle Stop)

If the boarding/disembarking lever is left up, the engine will stop automatically. This eliminates wasteful idling during standby, saving fuel and reducing CO<sub>2</sub> emissions as well.

Delivering  
class-leading  
fuel efficiency.

The new arm interflow system more efficiently controls hydraulic fluid flow, and delivers a significant reduction of in-line resistance and pressure loss boosts fuel efficiency. The engine, already well-known for its environmental performance has a new SCR\*system, and its reduced NOx emissions.

\* SCR: Selective Catalytic Reduction

## Built to operate in tough working environments

### Hydraulic Drive for Engine Cooling Fan, Independent Oil Cooler Fan

Hydraulic drive optimises the cooling fan rotation speed to improve fuel economy and reduce noise. The independent oil cooler fan better matches cooling to the hydraulic oil temperature, for optimal oil temperature control.

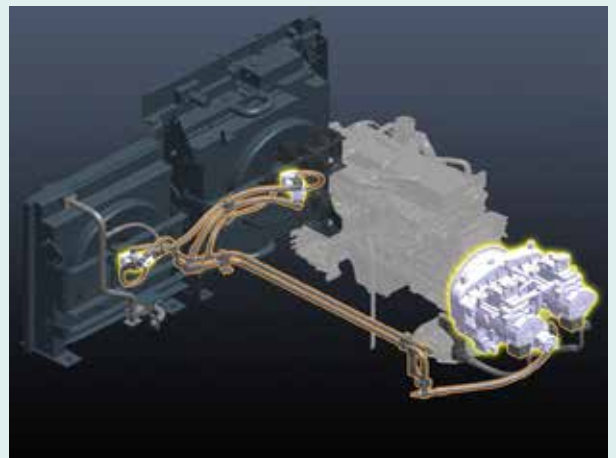
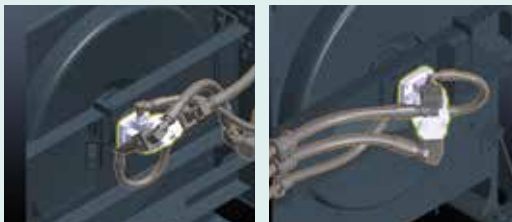

## Engine

### Next-Generation Electronic Engine Control

The new electronic-control common-rail engine features high-pressure fuel injection and multiple injection with improved precision. It is fitted with an EGR cooler, and DP filter which deliver high output from optimised combustion and greatly reduce PM and NOx emissions.



### VG Turbo Reduces PM

The variable-geometry turbocharger adjusts air intake to maximise combustion efficiency. At low engine speeds the nozzles are closed, the turbo speed increased and air intake is boosted. This helps lower fuel consumption.

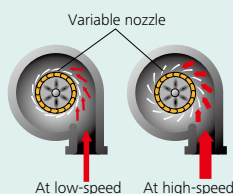

### SCR System with DEF/Urea **NEW**

The engine exhaust system has an SCR system that converts NOx emissions into harmless nitrogen and water. Combining this with a post-exhaust gas treatment system that captures and disposes of PM.

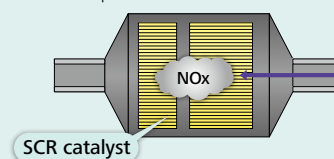

### EGR Cooler Reduces NOx

Cooled exhaust gases from the EGR cooler are mixed with fresh air in the intake. The recirculated air lowers the combustion temperature which reduces NOx.

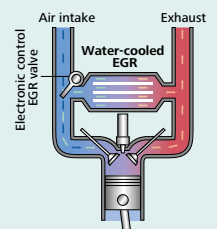

# Power Meets Efficiency for Increased Productivity

The highly efficient hydraulic system minimises fuel consumption while maximising power. With nimble movement and ample digging power, this excavator promises to improve your job productivity.

## Superior Digging Force

■ Max. Bucket Digging Force

**403 kN** (ISO6015)

■ Max. Arm Crowding Force

**311 kN** (ISO6015)



## Improved Operability Leads to Increased Productivity

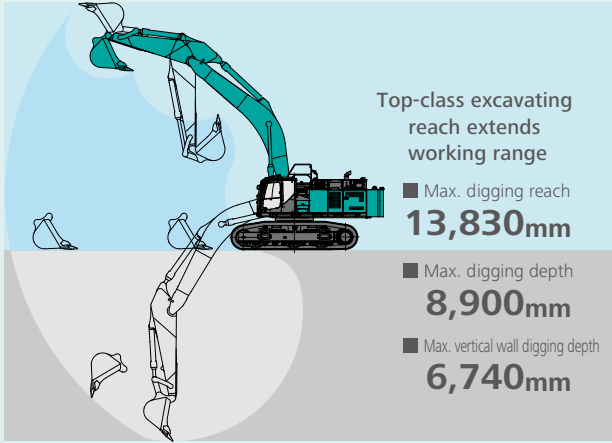

Values are for HD arm (3.6 m)

### Standard Quick Hitch Piping



A quick hitch hydraulic line, which speeds up attachment changes, is available as a standard.

### Low lever efforts for superior operator comfort NEW



Smooth and light operation lever reduces fatigue over long working hours or continued operations.

### Top Class Tractive Force

Powerful tractive force and pulling force deliver plenty of speed when climbing slopes or negotiating rough terrain, and the agility to change direction swiftly and smoothly.



■ Drawbar Pulling Force: **653kN**

### Variable Undercarriage Width

Crawler width can be adjusted by fixing bolt positions to comply with transport regulations.

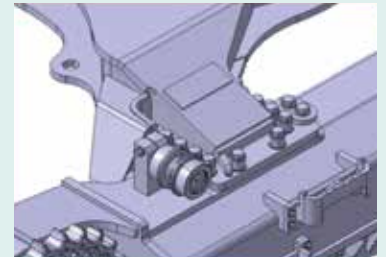

## Operator-friendly Features Include Controls that Are Easy to See, Easy to Use



### Multi-Display in Colour

Brilliant colours and graphic displays are easy to recognise on the LCD multi-display in the console. The display shows fuel consumption, maintenance intervals, and more.

- 1 Analogue gauge provides an intuitive reading of fuel level and engine water temperature
- 2 Green indicator light shows low fuel consumption during operation
- 3 PM accumulation display (left)/Urea level gauge (right)
- 4 Fuel consumption/Switch indicator for rear camera images
- 5 Digging mode switch
- 6 Monitor display switch

### One-Touch Attachment Mode Switch

A simple flick of a switch converts the hydraulic circuit and flow amount to match attachment changes. Icons help the operator to confirm the proper configuration at a glance.

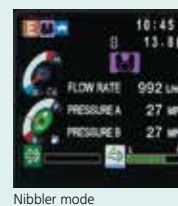
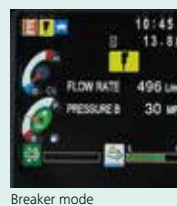

# Increased Power with Enhanced Durability for Superior Reliability and Productivity

Advanced hydraulic system design improves strength and performance while reducing machine downtime.

With enhanced power, reliability and durability, the SK850LC takes productivity to a new level.

## Improved Hydraulic System Reliability

Clean, contaminant-free fuel and hydraulic fluid are essential for a reliable performance. The improved filtration systems reduces the risk of mechanical trouble and enhances longevity and durability.

### Hydraulic Fluid Filter <sup>NEW</sup>

Recognised as the best in the industry, our super-fine filter separates out even the smallest particles. A new cover prevents contamination when changing filters.



Long-life hydraulic fluid:  
**5,000**  
hours

Hydraulic fluid filter replacement cycle is  
**1,000**  
hours

### Easy grease refill

Newly designed side door and catwalk are installed to right side body. Thanks to the door and catwalk, the refilling of grease is easier.

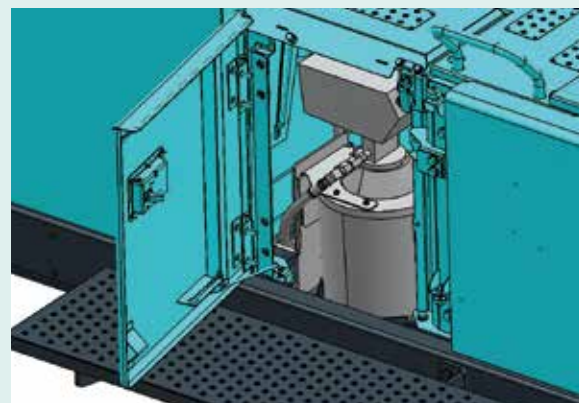

### Hydraulic Filter Restriction Indicator <sup>NEW</sup>

Pressure sensors at the inlet and outlet of the hydraulic oil filter monitor pressure difference to assess the degree of clogging. If the pressure difference exceeds a set level, a warning appears on the multi-display, so the filter can be cleaned before contamination reaches the hydraulic oil tank.

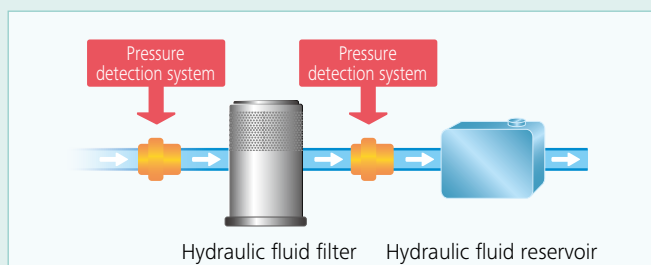

### Access door for grease gun

Access door to auto grease gun is at the front deck. The access door enables access to the auto grease gun from ground level.







### 500 Hour Attachment Lubrication Interval

Self-lubricating bushings are used at the attachment pins and bushings with high abrasion resistance are used on the bucket pins. The lubrication cycle of the lubrication points around the bucket is 250 hours and that of other lubrication points is 500 hours.



\* Additionally the two-piece bucket bushings protect the side of the arm from contact and then wear from the bucket ears. Should the bucket bushings need replacement, they can be replaced separately from the larger main bushing, reducing costs.

### Three Track Guides

Three heavy-duty track guides installed on each crawler side frame assure stability and reliability in the most demanding situations.



### Full Track Guides (Option)

Optional full track guides withstand powerful vibrations and eliminate de-track concern.



### Protective Lower Undercover (Option)

The undercover attached to the lower frame protects the hydraulic piping and equipment from flying rocks, bits of rebar, and other debris.



# A Cabin Designed For Operator Comfort and Visibility

A work environment that is quieter and more comfortable. A cab that puts the operator first is key to improved productivity.



## Comfort

### Super-Airtight Cab



The high level of air-tightness keeps dust out of the cab.

### Quiet Operator Station

The sealed and pressurised operator station with a high level of air-tightness ensures a quiet, comfortable cabin interior.

### Low Vibration Cabin

Coil springs absorb small vibrations, and high suspension mounts filled with silicone oil reduce heavy vibration. The long stroke achieved by this system provides the cabin with excellent protection from vibration.

Twice the stroke of a conventional mount

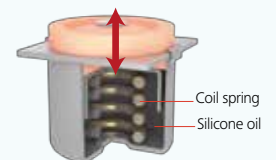

### High Visibility Operator Station

The front window features one large piece of glass without a centre pillar on the right side for a wide, unobstructed view.

## High Performance Air Conditioning System



The large air-conditioner has vents on the back pillars that blow air from behind and to the right and left of the operator's seat. They can be adjusted to put a direct flow of cool/warm air on the operator, for a more comfortable operating environment.



## Large Cab Is Easy to Get In and Out of

The expanded cab provides plenty of room for a large door, more headroom and smoother entry and exit.

## A Comfortable Seat Means A More Productive Operator



Air suspension seat absorbs vibration



Seat recliner can be pushed back flat



Double slides allow adjustment for optimum comfort

## Interior Equipment Adds to Comfort and Convenience



Bluetooth installed AM/FM stereo radio



USB/AUX/12V power outlet



Spacious storage tray



Large cup holder

## Safety



Mounting brackets for vandalism guards are standard equipment (contact your KOBELCO dealer to fit vandalism or front rock guards).



TOP Guard is fitted as standard.  
\*Working lights are optional.

## Expanded Field of View for Greater Safety



Rear view camera

Right side view camera



Hammer for emergency exit

### Right Side Camera Fitted as Standard

In addition to the existing rear view camera, a camera for the right side is fitted as standard, for quick safety checks around the machine.

# Engineered With Efficient Serviceability For Increased Uptime

## Easy Maintenance Means Reduced Machine Downtime

### Bolted Double Service Doors Open and Close Easily

- Intercooler
- A/C condenser
- Fuel cooler
- Radiator
- Oil cooler



### • Air cleaner



### • Refueling pump



### Auto-Coil Grease Gun Holder

- Grease tank
- Lubrication hose



### DEF/ AdBlue® tank\*

Located inside the standard machine storage compartment

\* AdBlue® is a registered trade mark of the Verband der Automobilindustrie e. V. (VDA).

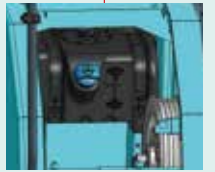

### • Battery



### • Battery disconnect switch



### Simple Filtration

- Hydraulic oil filter x 3



### • Suction filter

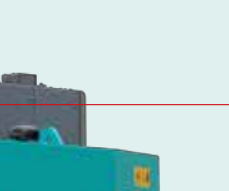

### Engine Compartment



### • Fuel filter



### • Fuel pre-filter with water separator



### • Engine oil drain valve



### • Engine oil filter



### • Drain filter



### • Large tool box



### • Cat walk



### • Rear swing flashers

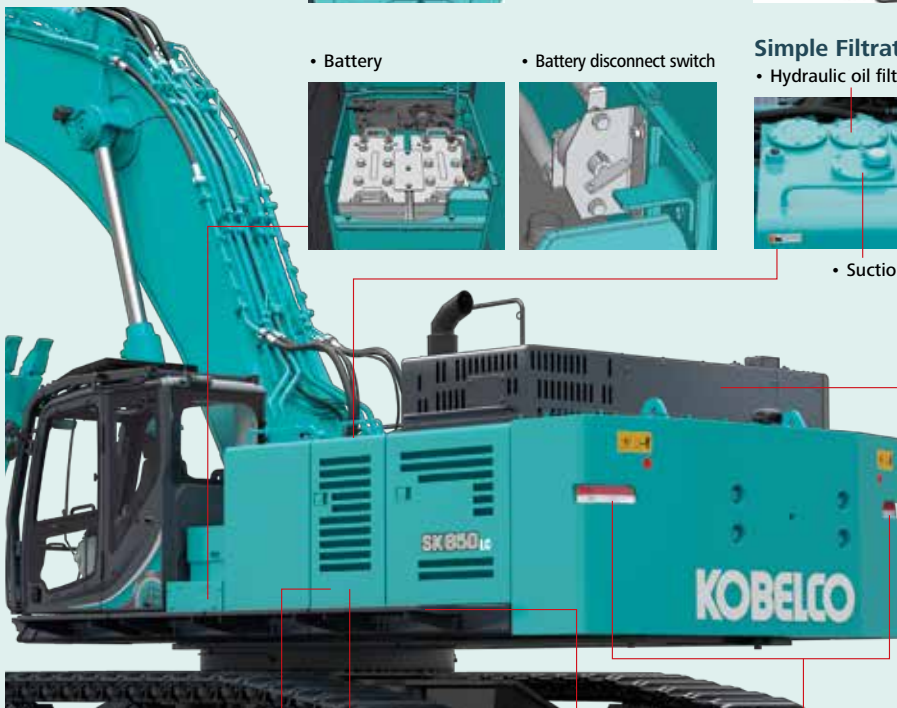

Daily maintenance checks are essential for the successful operation of large, continuously operating excavators. Inspections and maintenance must be quick and easy to maximise productivity. With its maintenance walk, the SK850LC provides easy access to essential components and systems to keep downtime at a minimum.



## Easy Inspection of Swing Bearing, Gear and Bolt

A small access port is located in front of the upper frame to make it easier to inspect the swing bearing, gear and bolt.



## Easy Access to In-cab Maintenance Features



Easy-access fuse box.



DPF Manual Regeneration Switch



Air conditioner filter can be easily removed without tools for cleaning. One for outside air and one for inside air.

## Easy Cleaning



Special sloped crawler side frame design is easily cleaned of mud.



Detachable two-piece floor mat with handles for easy removal.



Fuel tank features bottom flange and large drain valve for easy maintenance.

## Total Support for Machines with Network Speed and Accuracy

The GEOSCAN Remote Monitoring System is a satellite and cellular based system for remotely monitoring machine information and managing routine maintenance. Manage your machines anywhere in the world, with location, workload, maintenance information and diagnostic data available 24/7 via the GEOSCAN website.

### Direct Access to Operational Status

#### Location Data

Accurate location data can be obtained even from sites where communications are difficult.

#### Operating Hours

A comparison of operating times of machines at multiple locations shows which locations are busier and more profitable.

Operating hours on site can be accurately recorded, for running time calculations needed for rental machines, etc.

#### Fuel Consumption Data

Data on fuel consumption and idling times can be used to indicate improvements in fuel consumption.

#### Graph of Work Content

The graph shows how working hours are divided among different operating categories, including digging, idling, traveling, and hydraulic attachment use.



### Maintenance Data and Warning Alerts

#### Machine Maintenance Data

Provides maintenance status of separate machines operating at multiple sites. Maintenance data is also relayed to KOBELCO service personnel, for more efficient planning of periodic servicing.

### Security System

#### Engine Start Alarm

Sends a notification if the engine is started outside of pre-defined hours.

#### Area Alarm

Sends a notification if the machine leaves a pre-defined area.



## Engine

Model	HINO E13CYM
Type	Water-cooled, 4cycle 6cylinder electronically-controlled common rail system type diesel engine with turbo-charger
No. of cylinders	6
Bore and stroke	137 mm × 146 mm
Displacement	12.91 L
Rated power output	Net 380 kW / 1,800 min <sup>-1</sup> (ISO 14396 : without fan)
Max. torque	Net 2,120 N.m / 1,300 min <sup>-1</sup> (ISO 14396 : without fan)



## Hydraulic System

Pump	
Type	Two variable displacement pumps + One gear pump
Max. discharge flow	2 × 504 L/min, 1 × 30 L/min Extra gear pump 1 × 49 L/min
Relief valve setting	
Excavating circuits (main)	33.0 Mpa
Travel circuit	33.0 Mpa
Swing circuit	25.9 Mpa
Pilot control circuit	5.0 Mpa
Pilot control pump	Gear type
Main control valve	6-spool
Oil cooler	Air cooled type



## Swing System

Swing motor	Axial piston motor		
Parking brake	Oil disk brake, hydraulic operated automatically		
Swing speed	7.3 min <sup>-1</sup>		
Swing torque	268 kN·m		
Tail swing radius	4,580 mm		
Min front swing radius	3.6 m arm	6,340 mm	
	ME	5,470 mm	



## Travel System

Travel motors	2 x axial-piston, two-step motors
Travel brakes	Hydraulic brake per motor
Parking brakes	Wet multiple plate
Travel shoes	51 each side
Travel speed (high/low)	4.2 / 2.7 km/h
Drawbar pulling force	653 kN
Gradeability	70 % (35 deg)
Ground clearance	850 mm



## Cab & Control

Cab	
All-weather, sound-suppressed steel cab mounted on the high suspension mounts filled with silicone oil and equipped with a heavy, insulated floor mat.	
Control	
Two hand levers or two foot pedals for forward and backward operations of each track independently.	



## Boom, Arm & Bucket

Boom cylinders	210 mm × 1,800 mm
Arm cylinder	220 mm × 2,175 mm
Bucket cylinder	200 mm × 1,570 mm



## Refilling Capacities & Lubrications

Fuel tank	960 L
Cooling system	74 L
Engine oil	54 L
Travel reduction gear	2 × 22 L
Swing reduction gear	2 × 21.5 L
Hydraulic oil tank	522 L tank oil level
	905 L hydraulic system
DEF/Urea tank	83 L

## Operating Weight & Ground Pressure

In standard trim, with HD 8.25 m boom, HD 3.60 m arm, 3.5 m<sup>3</sup> ISO heaped bucket and standard counterweight

Shaped		Double grouser shoes (even height)			
Shoe width		mm	650	750	900
Overall width of crawler		mm	4,200(3,400)	4,300(3,500)	4,450(3,800)
Operating weight	Without Full track guide	kg	80,800	81,400	82,600
	With Full track guide	kg	81,900	82,500	83,700
Ground pressure	Without Full track guide	kPa	109.3	95.5	80.7
	With Full track guide	kPa	110.8	96.8	81.8

In standard trim, with 7.25 m ME boom, HD 2.90 m arm, 5.1 m<sup>3</sup> ISO heaped bucket and Standard counterweight

Shaped		Double grouser shoes (even height)			
Shoe width		mm	650	750	900
Overall width of crawler		mm	4,200(3,400)	4,300(3,500)	4,450(3,800)
Operating weight	Without Full track guide	kg	82,100	82,800	83,900
	With Full track guide	kg	83,200	83,900	85,000
Ground pressure	Without Full track guide	kPa	111.2	97.1	82.0
	With Full track guide	kPa	112.7	98.4	83.1

In standard trim, with HD 8.25 m boom, HD 3.60 m arm, 3.5 m<sup>3</sup> ISO heaped bucket and Heavy counterweight (+3tons)

Shaped		Double grouser shoes (even height)			
Shoe width		mm	650	750	900
Overall width of crawler		mm	4,200(3,400)	4,300(3,500)	4,450(3,800)
Operating weight	Without Full track guide	kg	83,800	84,400	85,600
	With Full track guide	kg	84,900	85,500	86,700
Ground pressure	Without Full track guide	kPa	113.4	99.1	83.7
	With Full track guide	kPa	114.9	100.4	84.7

In standard trim, with 7.25 m ME boom, HD 2.90 m arm, 5.1 m<sup>3</sup> ISO heaped bucket and Heavy counterweight (+3tons)

Shaped		Double grouser shoes (even height)			
Shoe width		mm	650	750	900
Overall width of crawler		mm	4,200(3,400)	4,300(3,500)	4,450(3,800)
Operating weight	Without Full track guide	kg	85,100	85,800	86,900
	With Full track guide	kg	86,200	86,900	88,000
Ground pressure	Without Full track guide	kPa	115.2	100.7	85.0
	With Full track guide	kPa	116.7	101.9	86.1

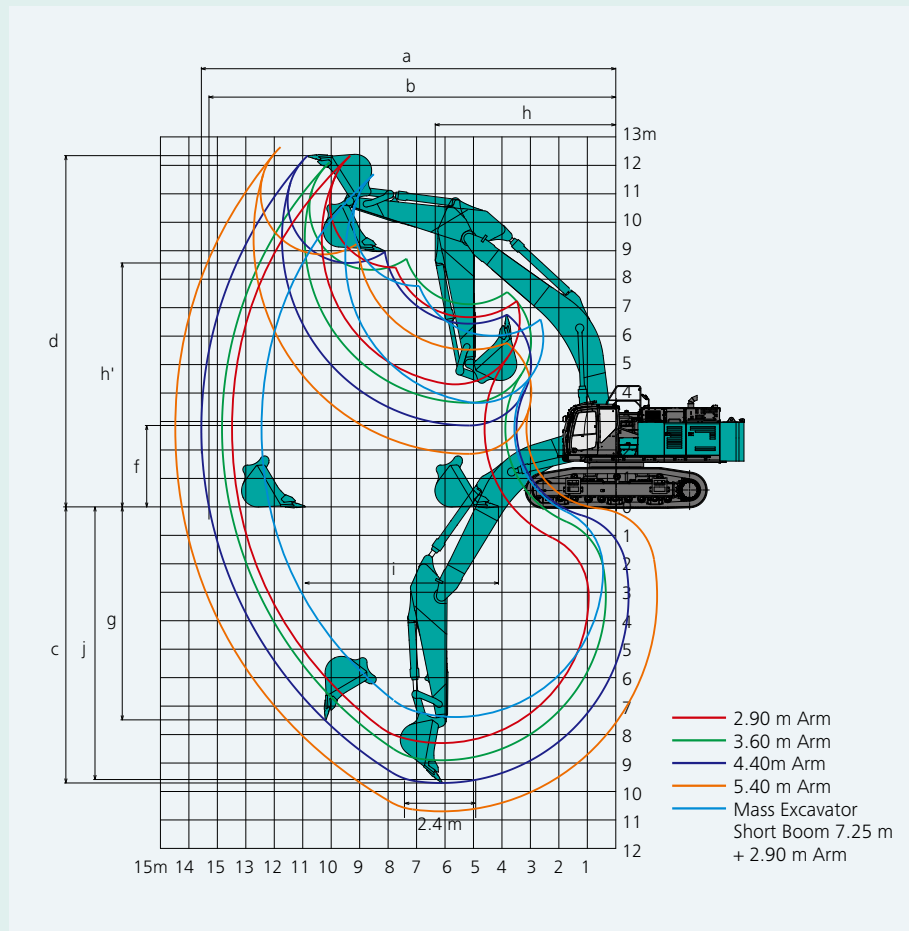

## Working Ranges

Unit: m

Boom		8.25 m				7.25 m
Arm		2.90 m	3.60 m	4.40 m	5.40 m	2.90 m
Range						
a- Max. digging reach		13.48	13.83	14.56	15.48	12.45
b- Max. digging reach at ground level		13.19	13.55	14.29	15.23	12.13
c- Max. digging depth		8.30	8.90	9.70	10.70	7.38
d- Max. digging height		12.34	12.11	12.35	12.64	11.69
e- Max. dumping clearance		8.41	8.34	8.57	8.87	7.77
f- Min. dumping clearance		4.31	3.67	2.86	1.86	3.66
g- Max. vertical wall digging depth		5.16	6.74	7.48	8.41	4.42
h- Min. swing radius		5.74	6.34	6.34	6.39	5.47
i- Horizontal digging stroke at ground level		4.36	5.67	6.80	8.08	4.37
j- Digging depth for 2.4 m (8') flat bottom		8.15	8.75	9.58	10.60	7.23
Bucket capacity SAE heaped m <sup>3</sup>		4.60	3.50	2.80	2.30	5.10

## Digging Force (ISO 6015)

Unit: kN

Boom		8.25 m				7.25 m
Arm length		2.90 m	3.60 m	4.40 m	5.40 m	2.90 m
Bucket digging force	ISO	432	403	403	403	432
Arm crowding force	ISO	351	311	272	234	351



## Attachments

Boom	Arm
<b>7.25 m ME Boom</b> Weight: 8,060 kg 	<b>2.90 m</b> Weight: 4,070 kg 
<b>8.25 m Standard Boom</b> Weight: 8,440 kg 	<b>2.9 m</b> Weight: 4,070 kg 
	<b>3.6 m</b> Weight: 4,180 kg 
	<b>4.4 m</b> Weight: 4,660 kg 
	<b>5.4 m</b> Weight: 5,300 kg 

Use			Backhoe bucket					
Bucket capacity	ISO heaped	m <sup>3</sup>	2.3	2.8	3.5	4.3	5.1	
	Struck	m <sup>3</sup>	1.8	2.1	2.6	3.2	3.7	
Opening width	With side cutter	mm	1,470	1,680	2,000	1,930	2,310	
	Without side cutter	mm	1,370	1,580	1,900	1,760	2,140	
No. of bucket teeth			4	5	5	5	6	
Weight			kg	2,130	2,370	2,610	4,060	4,640
Combination	2.90 m short arm		○	○	○	◎	–	
	3.60 m standard arm		○	○	◎	△	–	
	4.40 m long arm		○	◎	△	–	–	
	5.40 m long arm		◎	△	–	–	–	
	2.90 m short arm + 7.25m ME boom		–	–	–	–	◎	

◎ Standard ○ Recommend △ Loading only





## Dimensions

Unit: mm

Boom	8.25 m					7.25 m
Arm length	2.90 m	3.60 m	4.40 m	5.40 m	2.90 m	
A Overall length	14,600	14,530	14,480	14,220	13,590	
B Overall height (to top of boom)	4,580	4,760	5,160	5,750	4,880	
C Overall width	Extended	4,440				
	Retracted	3,400				
D Overall height (to top of cab)	3,770					
E Ground clearance of rear end*	1,560					
F Ground clearance*	850					
G Tail swing radius	4,580					
G' Distance from centre of swing to rear end	4,480					
H Tumbler distance	5,140					
I Overall length of crawler	6,380					
J Track gauge	Extended	3,550				
	Retracted	2,750				
K Shoe Width	650					
L Overall width of upperstructure	4,170**					
M Overall length of upperstructure	6,350***					

\* Without including height of shoe lug \*\*With catwalk \*\*\*With cab guard

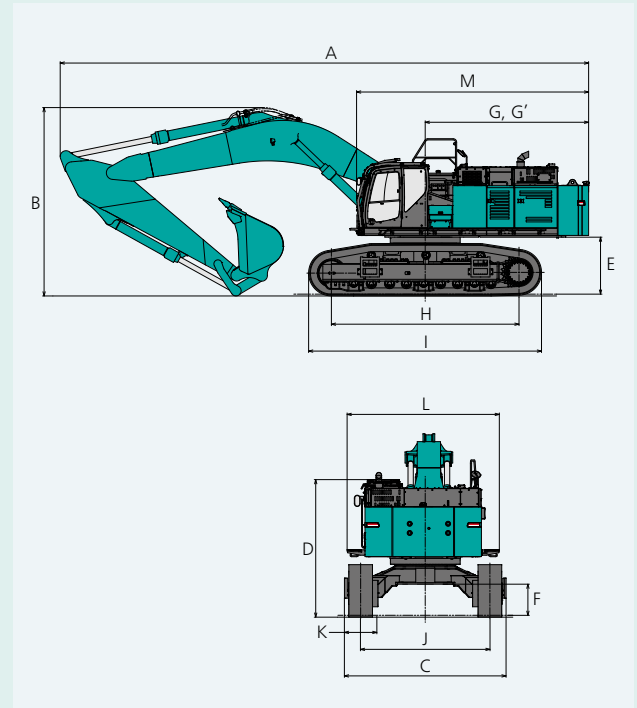

### Four Disassembly and Transport Patterns

The SK850LC can be disassembled and transported in four different ways, including: no counterweight, with boom attached; main body only; main body without crawler frame; etc.

### Variable Gauge Crawler

The variable gauge crawler extends the crawlers for extremely stable operation, and retracts them for easier transport.

### Crawler Width

Shoe	650 mm
Extended	4,200 mm
Retracted	3,400 mm

Configuration	Description	Total weight
<b>Plan 1</b>  Transportation with: 3,400 mm / 650 mm shoe	Base machine without counterweight and bucket, with lower structure, 8.25 m boom and 3.60 m arm	66,270 kg
<b>Plan 2</b>  Transportation with: 3,400 mm / 650 mm shoe	Base machine without counterweight, bucket and arm, with lower structure and 8.25 m boom	60,260 kg
<b>Plan 3</b>  Transportation with: 3,400 mm / 650 mm shoe	Base machine with lower structure, without counterweight, bucket, arm and boom,	49,340 kg
<b>Plan 4</b>  Transportation width: 3,190 mm	Base machine with carbody, without counterweight, bucket, arm, boom and lower structure	27,570 kg

Standard counterweight: 13,300 kg

# Lift Capacities

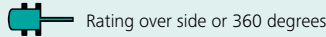
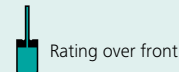
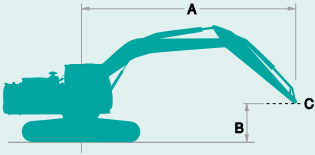

A: Reach from swing centreline to arm top  
 B: Arm top height above/below ground  
 C: Lift point  
 Bucket: Without bucket  
 Relief valve setting: 33.0 MPa

SK850LC		Boom: 8.25 m Arm: 3.60 m Bucket: without Shoe: 650 mm Standard counterweight: 13,300 kg															
B \ A		3.0 m		4.5 m		6.0 m		7.5 m		9.0 m		10.5 m		At Max. Reach		Radius	
10.5 m	kg														14,510	*14,510	8.65 m
9.0 m	kg									*14,130	*14,130				*14,090	*14,090	9.82 m
7.5 m	kg									*14,590	*14,590	*13,980	13,720	*13,970	13,380	10.64 m	
6.0 m	kg							*17,640	*17,640	15,540	15,540	*14,320	13,450	*14,020	12,020	11.20 m	
4.5 m	kg					*25,280	*25,280	19,740	19,740	16,740	16,540	*14,950	13,050	*14,180	11,190	11.54 m	
3.0 m	kg							21,710	20,500	*17,940	15,830	15,630	12,630	*14,430	10,750	11.66 m	
1.5 m	kg					30,260	26,900	23,130	19,640	*18,900	15,250	*16,190	12,270	14,750	10,650	11.59 m	
G.L.	kg					*30,530	26,480	23,800	19,150	19,430	14,870	*16,450	12,040	15,120	10,880	11.31 m	
-1.5 m	kg			*23,770	*23,770	29,770	26,450	*23,650	18,970	19,370	14,720	*16,150	11,980	15,500	11,540	10.82 m	
-3.0 m	kg	*25,790	*25,790	*35,200	*35,200	*28,050	26,710	22,610	19,080	18,480	14,800			15,850	12,820	10.07 m	
-4.5 m	kg	38,450	38,450	*31,070	*31,070	25,110	25,110	20,330	19,480	16,030	15,240			*16,020	15,240	9.00 m	
-6.0 m	kg			24,640	24,640	20,110	20,110							*15,550	*15,550	7.48 m	

SK850LC		Boom: 7.25 m Arm: 2.90 m Bucket: without Shoe: 650 mm Heavy counterweight: 16,300 kg														
B \ A		3.0 m		4.5 m		6.0 m		7.5 m		9.0 m		At Max. Reach		Radius		
9.0 m	kg							*18,680	*18,680					*18,750	*18,750	7.98 m
7.5 m	kg							*18,920	*18,920					18,170	18,170	8.98 m
6.0 m	kg					*23,740	*23,740	*20,240	*20,240	18,360	18,360	17,980	17,360	17,980	17,360	9.64 m
4.5 m	kg					27,360	27,360	22,050	22,050	*19,160	18,930	*18,000	16,040	*18,000	16,040	10.03 m
3.0 m	kg					*30,510	*30,510	23,800	23,800	*20,050	18,410	18,160	15,430	18,160	15,430	10.17 m
1.5 m	kg					*32,110	31,840	*24,980	23,160	20,670	18,000	*18,380	15,400	*18,380	15,400	10.09 m
G.L.	kg					32,070	31,440	25,250	22,780	20,650	17,770	*18,620	15,970	*18,620	15,970	9.77 m
-1.5 m	kg			*38,100	*38,100	*30,580	*30,580	*24,350	22,730	19,430	17,830	18,760	17,380	18,760	17,380	9.19 m
-3.0 m	kg	*39,190	*39,190	*34,160	*34,160	*27,420	*27,420	*21,700	*21,700					*18,560	*18,560	8.29 m
-4.5 m	kg			*26,740	*26,740	21,380	21,380							*17,310	*17,310	6.94 m

**Notes:**

- Do not attempt to lift or hold any load that is greater than these lift capacities at their specified lift point radius and heights. Weight of all accessories must be deducted from the above lift capacities.
- Lift capacities are based on machine standing on level, firm, and uniform ground. User must make allowance for job conditions such as soft or uneven ground, out of level conditions, side loads, sudden stopping of loads, hazardous conditions, experience of personnel, etc.
- Arm top pin is defined as lift point.
- The above lift capacities are in compliance with ISO 10567. They do not exceed 87% of hydraulic lift capacity or 75% of tipping load. Lift capacities marked with an asterisk (\*) are limited by hydraulic capacity rather than tipping load.
- Operator should be fully acquainted with the Operator's and Maintenance Instructions before operating this machine. Rules for safe operation of equipment should be adhered to at all times.
- Lift capacities apply to only machine as originally manufactured and normally equipped by KOBELCO CONSTRUCTION MACHINERY CO., LTD.



## STANDARD EQUIPMENT

### ENGINE

- Engine, HINO E13CYM-KSDB, diesel engine with turbocharger and intercooler
- Auto idle stop (AIS)
- Automatic engine deceleration
- Batteries (2 x 12 V, 245H52)
- Starting motor (24 V -7 kW), 90 amp alternator
- Removable clean-out screen for radiator
- Automatic shut-down for low engine oil pressure
- Engine oil pan drain valve
- Double element air cleaner x 2
- Hydraulic driven cooling fan
- Battery disconnect switch

### CONTROL

- Working mode selector (H-mode, S-mode and ECO-mode)
- Boom & Arm safety valve
- Extra N&B piping (proportional hand control) without ME ver.

### BOOM, ARM & BUCKET

- 8.25m HD boom
- 3.60m HD arm
- Bucket less

### SWING SYSTEM & TRAVEL SYSTEM

- Swing rebound prevention system
- Straight propel system
- Two-speed travel with automatic shift down
- Sealed & lubricated track links
- Grease-type track adjusters
- Automatic swing brake
- MVLC
- 650 mm HD double grouser shoe

### HYDRAULIC

- Auto warm up system
- Aluminum hydraulic oil cooler
- Hydraulic fluid filter clog detector
- Quick hitch piping

### MIRRORS, LIGHTS & CAMERAS

- Four front working lights
- Rear and right side camera
- Three rear view mirrors, side mirror

### CAB & CONTROL

- Two control levers, pilot-operated
- Horn, electric
- Cab light (interior)
- Luggage tray
- Large cup holder
- Detachable two-piece floor mat
- Headrest
- Handrails
- Intermittent windshield wiper with double-spray washer
- Skylight
- Tinted safety glass
- Pull-up type front window and removable lower front window
- Easy-to-read multi-display colour monitor
- Automatic air conditioner
- Emergency escape hammer
- Air suspension seat with heater
- Radio, AM/FM stereo with speaker
- TOP guard (ISO 10262:1998)
- GEOSCAN
- Cat walk (left and front of the right side)
- Lower Under Cover
- Air conditioning system  
The air conditioning system on this machine contains fluorinated greenhouse gas HFC-134a(GWP 1430).  
Quantity of gas 1.1kg (CO<sub>2</sub> equivalent 1.6t)
- USB pin
- Front Guard
- Travel alarm
- Refueling pump

## OPTIONAL EQUIPMENT

- ME specification
- Various optional arms
- Wide range of shoes
- Full track guide
- Two cab lights
- Heavier counterweight (+3,000kg)
- Rain visor (may interfere with bucket action)
- Reinforced lower under cover (t: 9mm)
- Hoisting kit

Note: Standard and optional equipment may vary. Consult your KOBELCO dealer for specifics.

Note: This catalogue may contain attachments and optional equipment that are not available in your area. And it may contain photographs of machines with specifications that differ from those of machines sold in your areas. Please consult your nearest KOBELCO distributor for those items you require. Specialist equipment is needed to use this machine in demolition work. Before using it please contact your KOBELCO dealer. Due to our policy of continuous product improvements all designs and specifications are subject to change without advance notice. Copyright by **KOBELCO CONSTRUCTION MACHINERY CO., LTD.** No part of this catalog may be reproduced in any manner without notice.

## KOBELCO CONSTRUCTION MACHINERY CO., LTD.

5-15, Kitashinagawa 5-chome, Shinagawa-ku, Tokyo 141-8626 JAPAN  
Tel: +81 (0) 3-5789-2146 Fax: +81 (0) 3-5789-2135  
www.kobelcocm-global.com

Inquiries To: